

# 5335B

Power Meter



# Safety Summary

The following safety precautions apply to both operating and maintenance personnel and must be followed during all phases of operation, service, and repair of this instrument.



Before applying power to this instrument:

- Read and understand the safety and operational information in this manual.
- Apply all the listed safety precautions.
- Verify that the voltage selector at the line power cord input is set to the correct line voltage. Operating the instrument at an incorrect line voltage will void the warranty.
- Make all connections to the instrument before applying power.
- Do not operate the instrument in ways not specified by this manual or by B&K Precision.

Failure to comply with these precautions or with warnings elsewhere in this manual violates the safety standards of design, manufacture, and intended use of the instrument. B&K Precision assumes no liability for a customer's failure to comply with these requirements.

## Category rating

The IEC 61010 standard defines safety category ratings that specify the amount of electrical energy available and the voltage impulses that may occur on electrical conductors associated with these category ratings. The category rating is a Roman numeral of I, II, III, or IV. This rating is also accompanied by a maximum voltage of the circuit to be tested, which defines the voltage impulses expected and required insulation clearances. These categories are:

Category I (CAT I): Measurement instruments whose measurement inputs are not intended to be connected to the mains supply. The voltages in the environment are typically derived from a limited-energy transformer or a battery.

Category II (CAT II): Measurement instruments whose measurement inputs are meant to be connected to the mains supply at a standard wall outlet or similar sources. Example measurement environments are portable tools and household appliances.

Category III (CAT III): Measurement instruments whose measurement inputs are meant to be connected to the mains installation of a building. Examples are measurements inside a building's circuit breaker panel or the wiring of permanently-installed motors.

Category IV (CAT IV): Measurement instruments whose measurement inputs are meant to be connected to the primary power entering a building or other outdoor wiring.



Do not use this instrument in an electrical environment with a higher category rating than what is specified in this manual for this instrument.

**⚠ WARNING**

You must ensure that each accessory you use with this instrument has a category rating equal to or higher than the instrument's category rating to maintain the instrument's category rating. Failure to do so will lower the category rating of the measuring system.

**Electrical Power**

This instrument is intended to be powered from a CATEGORY II mains power environment. The mains power should be 115 V RMS or 230 V RMS. Use only the power cord supplied with the instrument and ensure it is appropriate for your country of use.

**Ground the Instrument****⚠ WARNING**

To minimize shock hazard, the instrument chassis and cabinet must be connected to an electrical safety ground. This instrument is grounded through the ground conductor of the supplied, three-conductor AC line power cable. The power cable must be plugged into an approved three-conductor electrical outlet. The power jack and mating plug of the power cable meet IEC safety standards.

**⚠ WARNING**

Do not alter or defeat the ground connection. Without the safety ground connection, all accessible conductive parts (including control knobs) may provide an electric shock. Failure to use a properly-grounded approved outlet and the recommended three-conductor AC line power cable may result in injury or death.

**⚠ WARNING**

Unless otherwise stated, a ground connection on the instrument's front or rear panel is for a reference of potential only and is not to be used as a safety ground. Do not operate in an explosive or flammable atmosphere.

**⚠ WARNING**

Do not operate the instrument in the presence of flammable gases or vapors, fumes, or finely-divided particulates.

**⚠ WARNING**

The instrument is designed to be used in office-type indoor environments. Do not operate the instrument

- In the presence of noxious, corrosive, or flammable fumes, gases, vapors, chemicals, or finely-divided particulates.
- In relative humidity conditions outside the instrument's specifications.
- In environments where there is a danger of any liquid being spilled on the instrument or where any liquid can condense on the instrument.
- In air temperatures exceeding the specified operating temperatures.
- In atmospheric pressures outside the specified altitude limits or where the surrounding gas is not air.
- In environments with restricted cooling air flow, even if the air temperatures are within specifications.
- In direct sunlight.

This instrument is intended to be used in an indoor pollution degree 2 environment. The operating temperature range is 0°C to 40°C and 20% to 80% relative humidity, with no condensation allowed. Measurements made by this instrument may be outside specifications if the instrument is used in non-office-type environments. Such environments may include rapid temperature or humidity changes, sunlight, vibration and/or mechanical shocks, acoustic noise, electrical noise, strong electric fields, or strong magnetic fields.

**Do not operate instrument if damaged**



If the instrument is damaged, appears to be damaged, or if any liquid, chemical, or other material gets on or inside the instrument, remove the instrument's power cord, remove the instrument from service, label it as not to be operated, and return the instrument to B&K Precision for repair. Notify B&K Precision of the nature of any contamination of the instrument.

**Clean the instrument only as instructed**



Do not clean the instrument, its switches, or its terminals with contact cleaners, abrasives, lubricants, solvents, acids/bases, or other such chemicals. Clean the instrument only with a clean dry lint-free cloth or as instructed in this manual. Not for critical applications



This instrument is not authorized for use in contact with the human body or for use as a component in a life-support device or system.

**Do not touch live circuits**



Instrument covers must not be removed by operating personnel. Component replacement and internal adjustments must be made by qualified service-trained maintenance personnel who are aware of the hazards involved when the instrument's covers and shields are removed. Under certain conditions, even with the power cord removed, dangerous voltages may exist when the covers are removed. To avoid injuries, always disconnect the power cord from the instrument, disconnect all other connections (for example, test leads, computer interface cables, etc.), discharge all circuits, and verify there are no hazardous voltages present on any conductors by measurements with a properly-operating voltage-sensing device before touching any internal parts. Verify the voltage-sensing device is working properly before and after making the measurements by testing with known-operating voltage sources and test for both DC and AC voltages. Do not attempt any service or adjustment unless another person capable of rendering first aid and resuscitation is present.

Do not insert any object into an instrument's ventilation openings or other openings.



Hazardous voltages may be present in unexpected locations in circuitry being tested when a fault condition in the circuit exists. **Fuse replacement**



Fuse replacement must be done by qualified service-trained maintenance personnel who are aware of the

instrument's fuse requirements and safe replacement procedures. Disconnect the instrument from the power line before replacing fuses. Replace fuses only with new fuses of the fuse types, voltage ratings, and current ratings specified in this manual or on the back of the instrument. Failure to do so may damage the instrument, lead to a safety hazard, or cause a fire. Failure to use the specified fuses will void the warranty. Servicing

** WARNING**

Do not substitute parts that are not approved by B&K Precision or modify this instrument. Return the instrument to B&K Precision for service and repair to ensure that safety and performance features are maintained.

For continued safe use of the instrument

- Do not place heavy objects on the instrument.
- Do not obstruct cooling air flow to the instrument.
- Do not place a hot soldering iron on the instrument.
- Do not pull the instrument with the power cord, connected probe, or connected test lead.
- Do not move the instrument when a probe is connected to a circuit being tested.

** WARNING**











## **CE Declaration of Conformity**

This instrument meets the requirements of:

### **EMC Directive**

- EN 61326-1 2006
- EN 61000-3-2-2006
- EN 61000-3-3:1995

## Safety Symbols

	Refer to the user manual for warning information to avoid hazard or personal injury and prevent damage to instrument.
	Electric Shock hazard
	Alternating current (AC)
	Chassis (earth ground) symbol.
	Ground terminal
	On (Power). This is the In position of the power switch when instrument is ON.
	Off (Power). This is the Out position of the power switch when instrument is OFF.
	CAUTION indicates a hazardous situation which, if not avoided, will result in minor or moderate injury
	WARNING indicates a hazardous situation which, if not avoided, could result in death or serious injury
	DANGER indicates a hazardous situation which, if not avoided, will result in death or serious injury.
	NOTICE is used to address practices not related to physical injury.

# Contents

<b>Safety Summary</b>	<b>i</b>
CE Declaration of Conformity . . . . .	v
EMC Directive . . . . .	v
Safety Symbols . . . . .	vi
<b>Contents</b>	<b>vii</b>
<b>1 General Information</b>	<b>1</b>
1.1 Features . . . . .	1
1.2 Front Panel . . . . .	2
1.3 Rear Panel Summary . . . . .	3
1.4 Measurement Connection Setup . . . . .	3
1.5 Wiring External Current Sensors . . . . .	5
1.6 Power up . . . . .	6
1.6.1 Power Line Connection . . . . .	6
1.6.2 Fuse Requirements . . . . .	6
1.6.3 Power-up Sequence . . . . .	6
<b>2 Menu</b>	<b>7</b>
2.1 MENU > SYSTEM menus . . . . .	7
2.1.1 System Information Menu . . . . .	8
2.1.2 Communication Configuration Menu . . . . .	8
2.1.3 System Configuration Menu . . . . .	9
2.1.4 Self Test . . . . .	11
2.1.5 System Initialize Menu . . . . .	11
2.2 MENU > SETUP menus . . . . .	12
2.2.1 Averaging Setup . . . . .	15
2.2.2 External Sensor Setup . . . . .	15
2.2.3 Other settings . . . . .	15
2.2.4 Inrush Measurement Setup . . . . .	15
2.3 CAL ZERO . . . . .	15
2.4 RATIO SET . . . . .	15
<b>3 External Current Sensor</b>	<b>16</b>
<b>4 Front Panel Operation</b>	<b>17</b>
4.1 Measurement Setup . . . . .	17
4.1.1 Crest factor . . . . .	17
4.1.2 Set Measurement Range . . . . .	17
4.2 Voltage and current range . . . . .	18
4.2.1 Fixed range . . . . .	18
4.2.2 Auto Range . . . . .	18
4.3 Measurement interval . . . . .	19
4.4 Filter and Crest Factor Setting . . . . .	20



4.4.1	Filter . . . . .	20
4.5	Averaging Function . . . . .	21
4.5.1	Index averaging . . . . .	22
4.5.2	Linear averaging . . . . .	22
4.5.3	Harmonic measurement averaging . . . . .	22
<b>5</b>	<b>Meter Display</b> . . . . .	<b>23</b>
5.0.1	Operation steps . . . . .	23
<b>6</b>	<b>Waveform Display Function</b> . . . . .	<b>25</b>
6.1	Basic Concepts . . . . .	25
6.1.1	Introduction of soft keys on the interface . . . . .	25
6.1.2	Vertical calibration . . . . .	27
6.1.3	Horizontal calibration . . . . .	27
6.1.4	Trigger delay . . . . .	27
6.1.5	Trigger waveform . . . . .	27
6.2	Adjustment of Measurement Parameters . . . . .	27
6.2.1	Operation steps . . . . .	28
6.3	Setting of Trigger Configuration . . . . .	28
6.3.1	External trigger input (Ext) . . . . .	28
<b>7</b>	<b>Harmonic Measurement Function</b> . . . . .	<b>30</b>
7.1	Basic Concepts . . . . .	30
7.1.1	Introduction of harmonic information . . . . .	31
7.2	Setting of Harmonic Measurement Configuration . . . . .	31
7.2.1	Parameter descriptions: . . . . .	32
7.2.2	PLL source . . . . .	33
7.2.3	Harmonic analysis order . . . . .	34
<b>8</b>	<b>Integral Operation Function</b> . . . . .	<b>36</b>
8.1	Basic Concepts . . . . .	36
8.2	Introduction of soft keys on the interface . . . . .	37
8.3	Integral measurement display information . . . . .	37
8.3.1	Integral operation . . . . .	38
8.4	Specification . . . . .	38
8.5	Setting of Integral Measurement Configuration . . . . .	39
8.5.1	Parameter descriptions: . . . . .	40
8.6	Integration . . . . .	41
<b>9</b>	<b>Remote Operation</b> . . . . .	<b>42</b>
9.1	RS-232 Interface . . . . .	42
9.1.1	RS-232 troubleshooting . . . . .	42
9.1.2	RS-232 Communication settings . . . . .	43
9.2	USB interface . . . . .	43
9.3	GPIB interface . . . . .	44
9.4	LAN interface . . . . .	44
<b>10</b>	<b>Specifications</b> . . . . .	<b>45</b>
<b>11</b>	<b>Routine Maintenance</b> . . . . .	<b>49</b>
11.1	Self-inspection . . . . .	49
11.2	Error Information References . . . . .	49
11.2.1	Prompt Message List . . . . .	49
11.2.2	Error information list . . . . .	49
11.3	Daily maintenance . . . . .	51

11.3.1	Equipment cleaning . . . . .	51
11.3.2	Initialize . . . . .	51
11.4	Troubleshooting . . . . .	52
<b>12</b>	<b>LIMITED THREE-YEAR WARRANTY</b>	<b>54</b>
<b>13</b>	<b>Service Information</b>	<b>55</b>

# Chapter 1

## General Information

**Note:** The contents of this manual and included specifications are subject to change go to for the latest version. (Manual version: 2017-10-13 )

Figure 1.1 shows a schematic Diagram of Front Panel of BK5335B Series Power Meter and Diagram of Key Functions.

The BK5335B power meter measures AC and DC inputs up to 600 Vrms and 20 Arms from DC to 100kHz. It measures voltage, current, power, frequency, power factor, phase and harmonic parameters up to the 50th order. Remote control is available over USB, GPIB, RS232 and LAN communication interfaces. Screen captures are saved via the USB peripheral port located on the front panel. Voltage and current measurement precision is nominally 0.1%.

### 1.1 Features





- 4.3-inch color LCD
- Configurable display of measurements in 3 formats
- Input range: 600Vrms/20Arms from DC to 100kHz
- Voltage, current, power, harmonics and other parameters are measured at the same time simultaneously
- Up to 0.1% voltage and current measurement accuracy
- Harmonic measurement up to the 50th-order harmonic
- Screen captures are saved to USB via the front panel connector
- Integration measurement of power produced or consumed
- Frequency measurement
- Remote control via USB, GPIB, RS232 and LAN communication interfaces

## 1.2 Front Panel



Figure 1.1: Front Panel

- |          |                  |           |                        |
|----------|------------------|-----------|------------------------|
| <b>1</b> | Power Button     | <b>6</b>  | Rotary Knob            |
| <b>2</b> | 4.3" LCD         | <b>7</b>  | Arrow Keys             |
| <b>3</b> | USB              | <b>8</b>  | Soft-keys              |
| <b>4</b> | Main Functions   | <b>9</b>  | Soft-keys              |
| <b>5</b> | Menu, Enter, ESC | <b>10</b> | Print (Screen Capture) |

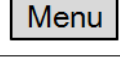
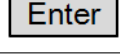
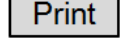
Key	Name and function
	Waveform Display key: press to view waveforms. See Chapter 6
	Harmonic Measurement key: For viewing harmonic measurements. See Chapter 7
	Basic Measurement key: The normal measurement screen. See Chapter ??
	Integral Measurement key: Measurements over time. See Chapter 8
	Menu key, Press to view and configure settings. See Chapter 2
	Enter key: Press to commit a setting or value.
	Image Save key: press to save a hardcopy of the screen to the USB host port on the front panel.

### 1.3 Rear Panel Summary



Figure 1.2: Rear View

1	GPIB Connector	6	AC Line
2	LAN Connector	7	External Current Sensor
3	USB Connector	8	Voltage Input
4	RS-232 Connector	9	Current Shunt Input
5	Synchronization BNC		

### 1.4 Measurement Connection Setup

Depending on the amount of current that will flow through the meter, 2 configurations are specified.

1. Remove the protective cover over the current input terminals. See Figure 1.3
2. Connect the circuit under measurement as shown in the wiring diagrams, Low current, see Figure 1.4, high current see Figure 1.5.
3. Use cables rated to conduct the current and withstand the voltage being measured.
4. For safety, re-attach the protective covers over the input terminals.



Figure 1.3: Current terminal cover

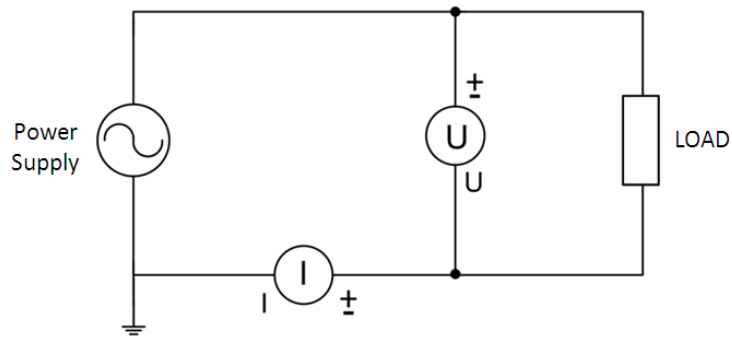

Figure 1.4: Low Current Wiring Setup

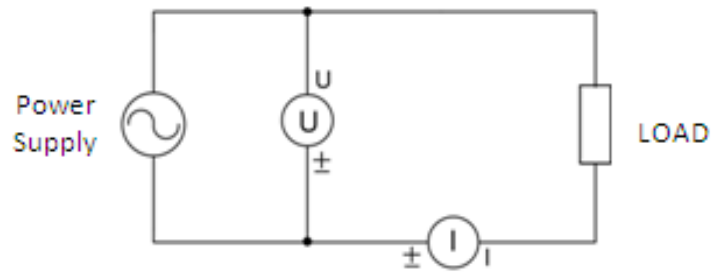

Figure 1.5: High Current Wiring Setup

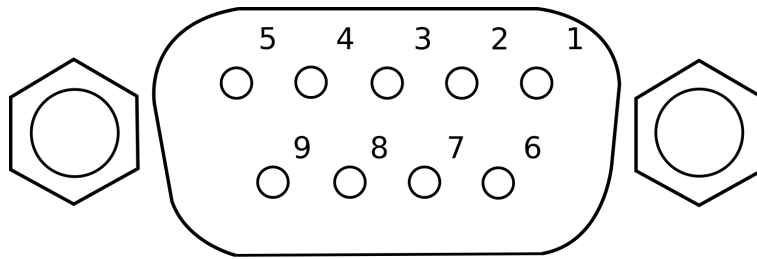

Figure 1.6: External Sensor Interface: DE-9 Connector

Pin #	Description
1	+12 V
2	GND
3	-12 V
4	Signal GND
5	Voltage
6	NC
7	Current
8	NC
9	NC

Table 1.1: External Sensor Connector Pinout

## 1.5 Wiring External Current Sensors

This power meter accepts a wide range of external current sensors. Measurement is achieved by applying a scaling factor to the voltage sensed at the external sensor input. A ratio of Volts to Amps is set in the EXSENSOR SET menu of the instrument. See Section 3 for details. Always disconnect the main current input when using an external sensor. The ports are electrically connected and if both are connected, measurement error and damage may occur.

1. Connect the power supply, external current sensor, electronic load and BK5335B Power Meter as shown in Figure 1.6
2. Turn on the power meter
3. Select Menu > SETUP > EXT SEN SET to access the External Sensor Setup interface
4. Use the arrow keys to select ExSENSOR2 or EXSENSOR1, and then press ON from the soft-keys to enable the external current sensor.
5. Set the “Ratio” using the arrow keys and knob to set the value in V/A (EXSENSOR1) or mV/A (ExSENSOR2)
6. Press Enter to save the settings
7. Press Esc to exit the settings

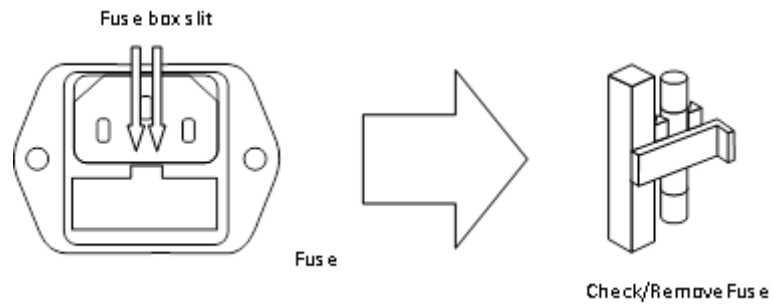

Figure 1.7: Fuse Holder

## 1.6 Power up

### 1.6.1 Power Line Connection

Input power requirements:

**AC Voltage** 110 V  $\pm$ 10% or 220 V  $\pm$ 10%

**Frequency** 47 Hz – 63 Hz

### 1.6.2 Fuse Requirements

An AC input fuse is necessary when powering the instrument. Refer to Table 1.2 for the fuse requirements.

Model	Fuse Specification (110 V)	Fuse Specification (220 V)
5335B	T 10 A, 250 V	T 6.3 A, 250 V

Table 1.2: Required Fuses

#### 1.6.2.1 Fuse Replacement

1. Disconnect the power cord.
2. Locate the fuse box in the rear panel, beneath the AC power socket. Figure 1.7
3. With a small flat blade screwdriver, insert the blade into the fuse box slit to pull and slide out the fuse box.
4. Pull out the fuse inside to check and/or replace with the appropriate fuse for the line voltage used.
5. Insert the fuse in the same location.

### 1.6.3 Power-up Sequence

Connect AC power cord to the AC receptacle in the rear panel and press the power switch to the (ON) position to turn ON the instrument. It will display the BIOS version then run through a self-test procedure, Figures ??, 2.9.



# Chapter 2

## Menu

Configuration of system-wide settings is done from the “Menu”. Pressing the **Menu** button enters the configuration/system menu, Figure 2.1.

From the main menu, the soft-keys at the bottom of the screen provide access to the configuration screens. See Table 2.1

### 2.1 MENU > SYSTEM menus

From the system menu, system-wide functions are set and viewed. Figure ??, details such as the LAN MAC address, date, screen brightness, system initialization (settings reset), and self test are accessed here. See Table 2.2

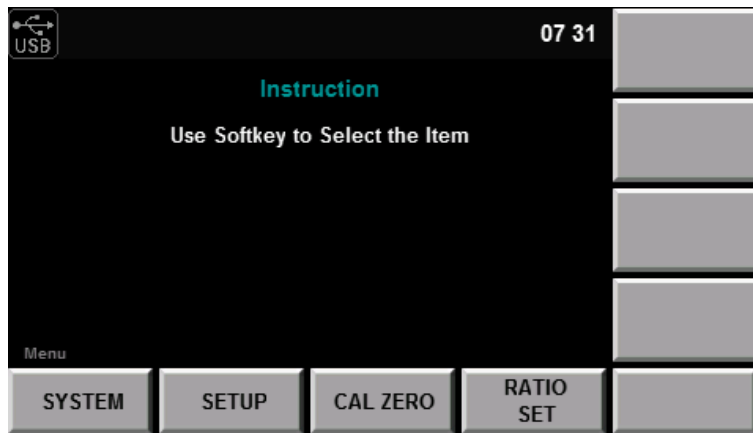

Figure 2.1: Configuration/System Menu

Function	Description
SYSTEM	View and change overall system information and parameters
SETUP	Device measurement and measurement configuration settings
CAL ZERO	Zero the meter
RATIO SET	Change the overall scaling factor for measurements

Table 2.1: Main “Menu” functions

Function	Description
SYSTEM INFO	System details, Model, Serial, etc...
COMM CONFIG	Setup the communication interfaces
SYSTEM CONFIG	Set date, time, beep and brightness
SELF TEST	Perform a self diagnostic
INITIAL	Reset device settings

Table 2.2: System Menu sub-menus



Figure 2.2: System Info Screen

### 2.1.1 System Information Menu

Information about the device is listed in this menu. The serial number listed is that used in production at the factory and does not match the label. When contacting B+K, use the serial number on the label.

### 2.1.2 Communication Configuration Menu

Available remote interfaces are RS-232, USBTMC, GPIB and LAN. For details about commands and use of the remote interfaces, see the programming manual. The manual is found on the product page of the 5335B at [www.bkprecision.com](http://www.bkprecision.com)

#### 2.1.2.1 RS-232

This interface support 6 common baudrates: 4800, 9600, 19200, 38400, 57600, 115200. Use the arrow keys to navigate the menu screen and the soft-keys to select the desired baudrate. The number of data bits, parity and stop bits are preset and unchangeable. (8 bits, no parity, and 1 stop bit, so called N-8-1). See Figure 2.3.

#### 2.1.2.2 USB

This unit operates as a USBTMC (USB Test and Measurement) device. There are no configuration options for this interface. Figure 2.4



Figure 2.3: COMM Configuration - RS-232



Figure 2.4: COMM Configuration - USB

### 2.1.2.3 GPIB

The GPIB interface may be configured to addresses 1 through 30. Use the arrow keys to select the numeric field beside “GPIB Address” and use the rotary knob to change the value. The user may select each digit by the arrow keys as well. Figure 2.5

### 2.1.2.4 LAN

The LAN (Ethernet) interface may be configured as either DHCP or static. Use the arrow keys to select the IP Mode field. When DHCP is selected, the current IP, subnet, and gateway are shown on screen (Figure 2.6). When “MANU” is selected (static mode) (Figure 2.7), the screen shows fields for setting the IP, subnet, and gateway. Using the arrow keys and the rotary knob allows the user to move between fields and digits, and use the rotary knob to change the value.

## 2.1.3 System Configuration Menu

From this menu, setting the date, time, brightness, and the state of the beep function is set. Use the arrow keys to navigate the fields, and the rotary knob to change the value. For the beep function, the soft keys are used to change the value. When settings are changed, press the  key to commit the changes. See Figure 2.8.



Figure 2.5: COMM Configuration - GPIB

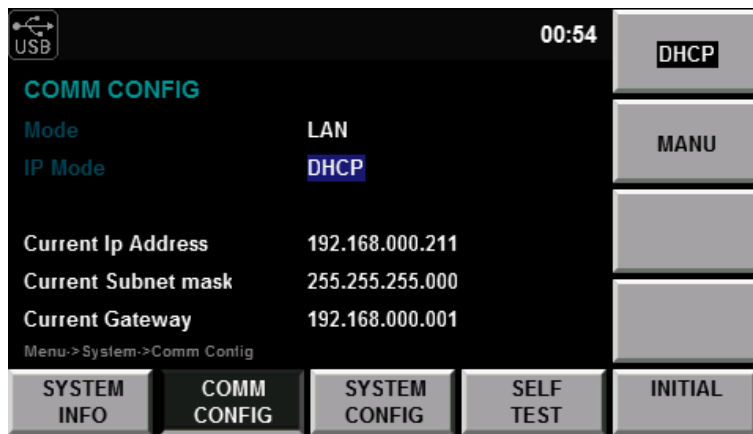

Figure 2.6: COMM Configuration - LAN (DHCP)

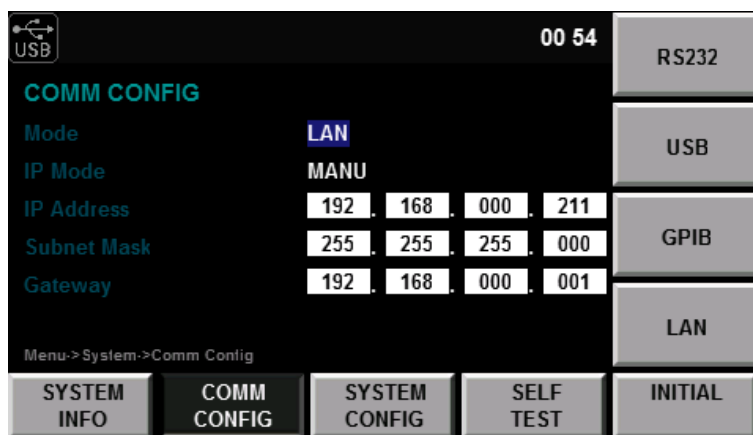

Figure 2.7: COMM Configuration - LAN (Manual (static))

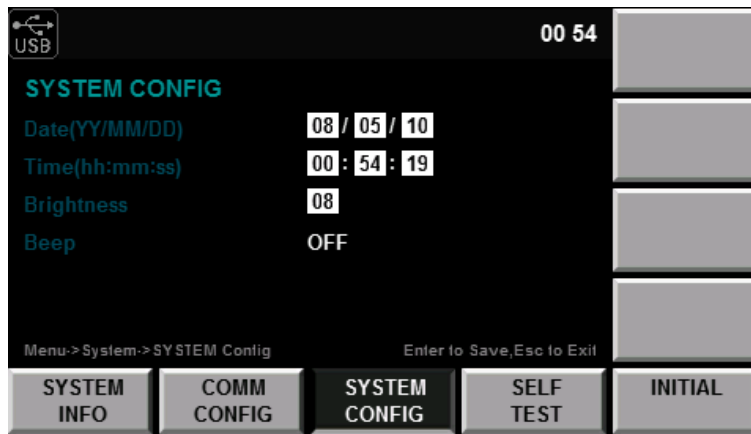

Figure 2.8: System Config Menu

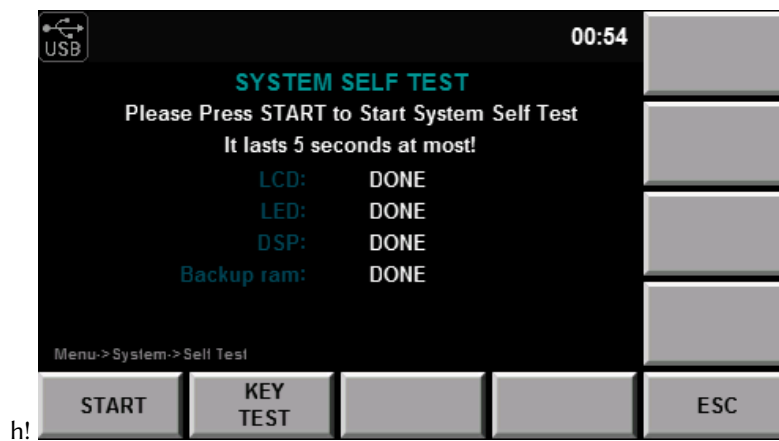

Figure 2.9: System Self Test

#### 2.1.4 Self Test

The unit has a built in self test. This function tests the LEDs, the screen and some of the internal electronics, Figure 2.9. When the test is running, it cycles through colors on the LCD, and lights up the individual LEDs that illuminate the front panel buttons. When complete, the results are displayed on screen, DONE for the LCD and LEDs, and OK for the internal electronic tests.

From this screen, a test of each button is also available. A representation of all the buttons appears on screen after selecting the “KEY TEST” key, pressing the individual keys will highlight the text on screen indicating the button is working. Press the  to exit the test.

#### 2.1.5 System Initialize Menu

System initialization will bring the manifold functions to their initial states. By navigating the functions listed on-screen and either selecting the check mark or the “x” via the soft-keys, the function will be initialized or left alone respectively. Figure 2.10

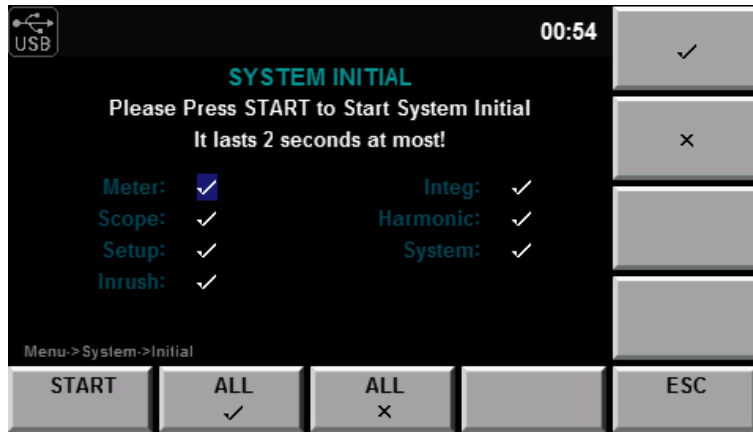

Figure 2.10: System Initialize Menu



Figure 2.11: Setup Information Screen

## 2.2 MENU > SETUP menus

From the “MENU” function, the next page is the “SETUP” soft-key (Figure 2.11). This screen essentially gives a summary of the settings controlling measurements.

Field	Description
Average	Listing of the average mode settings. See <i>Averaging Setup</i>
Sync Source	The measurement synchronization signal source. See ??
Line Filter	The state of the line filter.
Update rate	How often to measure?
Freq Filter	The state of the frequency filter.
Crest Factor	The Crest Factor setting state
ExSensor1	External Sensor 1 state (on/off)
ExSensor2	External Sensor 2 state (on/off)
U_Range	The voltage range setting.
Rate(V/A)	External Sensor 1's scale value
Rate(mV/A)	External Sensor 2's scale value
I_Range	The current range setting.



Figure 2.12: Ratio Set Menu



Figure 2.13: Ratio Set Menu



Figure 2.14: Ratio Set Menu



Figure 2.15: Ratio Set Menu



Figure 2.16: Calibration Menu



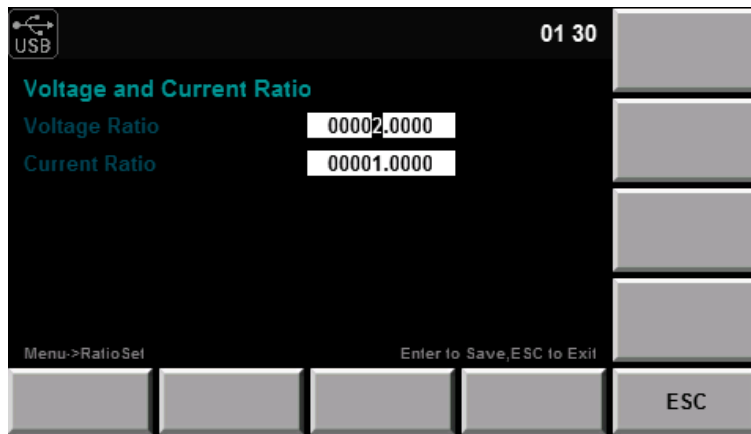

Figure 2.17: Ratio Setup Menu

### 2.2.1 Averaging Setup

### 2.2.2 External Sensor Setup

### 2.2.3 Other settings

### 2.2.4 Inrush Measurement Setup

## 2.3 CAL ZERO

## 2.4 RATIO SET

This setting has the effect of scaling the measured value of the current and voltage. For example, a 116 V signal becomes 232 V when the “Voltage Ratio” is set to 2. The Ranges are not effected by this setting, so the 150V range is still shown and used. Use the arrow keys to move between parameters and digits. Use the knob to change the value of the selected digit. To commit the setting change, press the  button. See Figure 2.17

## Chapter 3

# External Current Sensor

More information to be added in future versions of this documentation.

When using an external current sensor, the power meter has more current range options. See details Section ??.

Sensor Input	Crest Factor	Ranges
EXT1	Crest Factor 3 (CF=3)	2.5 V, 5 V, 10 V
EXT1	Crest Factor 6 (CF=6)	1.25 V, 2.5 V, 5 V
EXT2	Crest Factor 3 (CF=3)	50 mV, 100 mV, 200 mV, 500 mV, 1 V, 2 V
EXT2	Crest Factor 6 (CF=6)	25 mV, 50 mV, 100 mV, 250 mV, 0.5 V, 1 V

Table 3.1: External Sensor Ranges

## Chapter 4

# Front Panel Operation

### 4.1 Measurement Setup

Central to setting the proper range of the instrument is the Crest Factor. Crest factor is the ratio of the peak value of a waveform to the RMS value of the waveform. For example, a perfect sine wave crest factor RMS value is  $0.707 * \text{Peak}$ . The crest factor is the inverse of the normalized RMS value,  $0.707^{-1} = 1.414$ . In many cases, like the current waveform of a AC-DC power supply, the crest factor is a larger value. For accurate measurement, the signal measured should stay within the measurement range of the instrument. For example, a 100V RMS signal with a crest factor of 5 has peaks of 500V. If the range selected is smaller than 500V than inaccuracy will occur as the signal will be clipped.

#### 4.1.1 Crest factor

The Crest Factor, the ratio of the peak to the RMS value, has two settings, 6 or 3. This setting applies to both current and voltage simultaneously, and modifies the available ranges listed in Section 4.1.2. Essentially, by knowing the RMS signal level and the peak value, the setting of this parameter is determined. For an 117V RMS AC line signal with little distortion and a purely real load (power factor = 1), the peak value is  $1.414 * 117V = 165V$ . 1.414 is the approximate Crest Factor of a Sine wave. So, the appropriate setting will be 3 (CF3).

$$\text{CrestFactor}(CF) = \frac{\text{Peak}}{\text{RMS}}$$

As this meter also measures the DC level of the signal, this must also be accounted for when choosing the Crest Factor. If the the signal will exceed the range of the unit (crest factor \* range) then the measurement value will be clipped and the value inaccurate. Conversely, by choosing a Crest Factor and Range combination that accommodates the peak value of the signal, a larger crest factor than set may be measured. The trade-off is then the accuracy, and is listed in the specifications, Chapter 10.

**Example (Range=150 V, CF = 6):** The maximum input signal and crest factor are as follows:

$$V_{rms} = 100 \quad \text{Range} = 150V \quad V_{maxrange} = 900V$$

So, a signal with a peak that is 9 times that of the RMS value (Crest Factor 9) is measurable using these settings.

#### 4.1.2 Set Measurement Range

The appropriate measurement range (voltage and current range) must be set for accurate measurement.

1. In the “Meter” interface Press the soft key corresponding to either “U-RANGE” or “A-RANGE”, and use the knob or the arrow keys to select the voltage or current range desired. See Table 4.1
2. Press the “Enter” key to confirm the setting. Otherwise the instrument will automatically confirm and exit the setting after 5 seconds of no activity.

	CF 3	CF6
Voltage	15, 30, 60, 150, 300, 600 V	7.5, 15, 30, 75, 150, 300 V
Current	5, 10, 20, 50, 100, 200, 500 mA, 1, 2, 5, 10, 20 A	2.5 ,5 ,10 ,25 ,50 ,100 ,250 mA, 0.5, 1, 2.5, 5, 10 A

Table 4.1: Current and Voltage Ranges per Crest Factor setting

## 4.2 Voltage and current range

### 4.2.1 Fixed range

Select the required range from a number of options. For the voltage range, when the crest factor is 3, the maximum option is “600V” and the minimum option is “15V”. When the crest factor is 6, the maximum option is “300V” and the minimum option is “7.5V”. See Table 4.1



Measurement accuracy is improved by minimizing the range for a given input signal.

### 4.2.2 Auto Range

The measurement range adjusts automatically according to the input signal, and uses same ranges as in Fixed range mode. See Table 4.1.

Adjustment of the range occurs when the following conditions occur:

#### Increasing range

- Urms or Irms exceeds 110% of the current range setting.
- When the crest factor is 3, and the peak voltage or current exceeds 330% of the range currently set.
- When the crest factor is 6, and the peak voltage or current exceeds 660% of the range currently set.

#### Decreasing range

- Urms or Irms is less than or equal to 30% of the current measurement range.
- The crest factor is 3. The value Upk or Ipk of the input signal is less than 300% of the range at the following level.
- The crest factor is 6. The value Upk or Ipk of the input signal is less than 600 % of the range at the following level.



The selected automatic range may change when the input is a random pulse. In this case, a fixed range should be used.

### 4.3 Measurement interval

The measurement interval, the time during which data is taken. The fundamental frequency of the measured signals restricts the measurement intervals that yield meaningful results. For example, measuring 10Hz with an interval of less than the 0.5s setting will not yield stable results. The unit needs a number of cycles to be present to determine the frequency, and measurement intervals are not synchronized to the input.

**Note:** The scope timing parameters do not control the measurement interval.

- A cycle is determined by detecting zero crossings.
- Either positive, or negative going transitions of the synchronization source determine the measurement timing. If the zero crossings do not occur within the set update interval, the entire interval is used for calculating the various measurements. See Figure 4.1.  
The choice of rising or falling transition is determined as that which gives the greatest amount of time.
- For peak value measurements (Ipk+, Upk-, etc...), the entire update interval is used. Measurements of Crest Factor, as it is the Peak to RMS ratio, are also determined using the entire measurement update interval.
- The input signal used as the synchronization source is configurable, and determines the synchronization with the zero point of that input signal. The overall interval of the voltage, current or data updating cycle may be selected as the synchronization source.

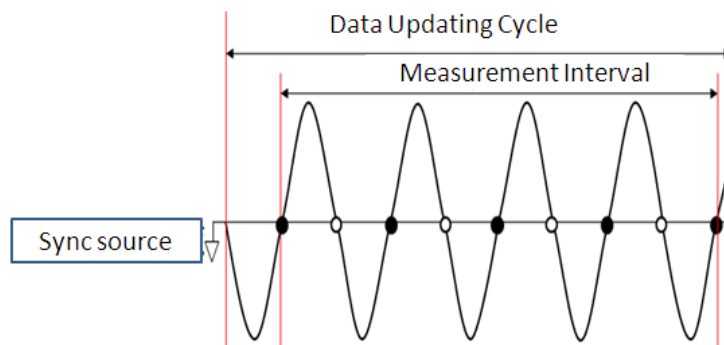

Figure 4.1: Measurement Timing

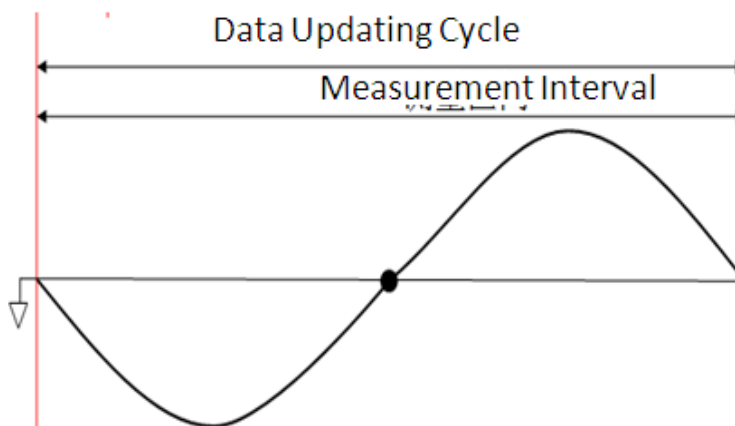

Figure 4.2: Measurement Timing 2



The data updating cycle refers to the cycle used for calculating sampling data of the measurement function. It is identical to the set value of the data updating rate.  
 The slope refers to signal changes from low level to high level (rising edge) or from high level to low level (descending edge).

### 4.4 Filter and Crest Factor Setting

1. Select Menu → SET UP → OTHER SET and enter the OTHER configuration page.
2. Press ▲ ▼ to select the parameter to be configured (blue font background), and then press the soft key corresponding to the parameter on the right to set the required value, as shown in the Figure ??.
3. Press the Enter key to save the settings.



Figure 4.3: Other Settings Display

Function	Description
Sync Source	Synchronization Source, the source used to determine the measurement interval. May be set to voltage (U), current (I) or turned off.
Freq Filter	Enable or disable the Frequency Filter.
Line Filter	Enable or disable the Line Filter.
Crest Factor	Set the crest factor to 3(CF3), or 6 (CF6) (See Section 4.1.1)
Update Rate	Data Update Rate: the capture interval of the voltage, current, power and other data can be set. When the data updating rate is increased, rapid load changes of the power system can be measured. Conversely, when decreased, relative low-frequency signals can be measured. Values = 0.1, 0.25, 0.5, 1, 2, and 5 seconds

Table 4.2: Other Set configuration settings

#### 4.4.1 Filter

**Frequency Filter** It is inserted in the frequency measurement circuit and may affect frequency measurement. It can be used for filtering high-frequency components of interference to make the measured frequency parameter

more accurate. When the frequency filter is switched on, the voltage or current of no more than 200Hz can be measured. The cutoff frequency is 500HZ.

**Line filter** It is inserted in the voltage and current measurement circuit and has direct influence on measurement of the voltage, current and power. When the line filter is switched on, noise and high-frequency components from the inverter or distortion waveform can be filtered. The cutoff frequency is 500HZ.

## 4.5 Averaging Function

1. Select **Menu** ⇒ **SET UP** ⇒ **AVERAG SET** to enter the configuration page of the averaging function.
2. Press **▲** **▼** to select the parameter to be configured (blue background), and press the soft key corresponding to the required value. See Figure 4.4.
3. Press the Enter button to confirm the setting.



Figure 4.4: Averaging Settings

Character	Function description
State	Enable or disable averaging.
Mode	Average mode Line=linear or Exp=cumulative moving average
Type	Averaging type. MOVING: moving averaging REPEAT: repeated averaging
Count	Set the times of the averaging function.

Table 4.3: Average Settings Menu

**Note:**

- If the mode of the averaging function is set as EXP (index averaging), the attenuation constant can be set.
- If the mode of the averaging function is set as LINE (linear averaging), the averaging times can be set.

### 4.5.1 Index averaging

$$D_n = D_{n-1} + \frac{M_n - D_{n-1}}{k}$$

$D_n$	The value displayed after the nth index averaging, ( $D_1$ , the value displayed after the first averaging, is equal to $M_1$ )
$D_{n-1}$	The value displayed after the (n-1)th index averaging
$M_n$	the nth measured data.
$k$	attenuation constant (1-64)

### 4.5.2 Linear averaging

$$D_n = \frac{M_{n-(m-1)} + \dots + M_{n-2} + M_{n-1} + M_n}{m}$$

$D_n$	linear average of m values from the $(n - (m - 1))^{th}$ to $n^{th}$ value
$M_{n-(m-1)}$	$(n - (m - 1))^{th}$ measured data
$M_{n-2}$	$(n - 2)^{th}$ measured data
$M_{n-1}$	$(n - 1)^{th}$ measured data
$M_n$	$n^{th}$ measured data
$M$	the number of average values (1-64)

When m can be divided exactly by n, the calculated value is the moving average; when there is no particular relationship between m and n, the calculated value is the repeated average.



When index averaging is set, averaging is implemented under the harmonic measurement function.

When linear averaging is set, averaging can only be implemented in the conventional measurement function and this mode is not applicable to the harmonic measurement function.

The following measurements are subject to direct averaging:

1. Urms, U<sub>mn</sub>, U<sub>dc</sub>, U<sub>rmn</sub>, U<sub>ac</sub>, Irms, I<sub>mn</sub>, I<sub>dc</sub>, I<sub>rmn</sub>, I<sub>ac</sub>, P, S and Q.
2. U<sub>cf</sub>, I<sub>cf</sub>,  $\lambda$  and WPAV are calculated by operation of the averaged Urms, Irms, P and S.

### 4.5.3 Harmonic measurement averaging

The following measurement functions are subject to direct averaging:

1. U(k), A(k), W(k), S(k) and Q(k).
2.  $\lambda(k)$  is calculated via operation of the averaged W(k) and Q(k).
3. U(%r), A(%r), W(%r), U(%f), A(%f) and W(%f) are calculated via operation of the averaged U(k), A(k) and W(k). (k indicates the harmonic times.)



## Chapter 5

# Meter Display

The 5335B has 3 configurable display formats. Each format also allows for 5 different configured sets of measurement. 1 large and 6 small, 4 large and 6 small, or 12 small measurements may be displayed. See Figures 5.1, 5.2, 5.3.

### 5.0.1 Operation steps

1. Press **Menu**
2. The “View” soft-keys select the display format (1,4,12). Repeated press of the soft-key cycles through the different configurations, up to 5 of them.
3. The “CONFIG” soft-key enters the configuration mode for that set of pages.
4. The “FUNC” soft-key cycles through the sets of measurements available for Power (P), Current (I), and Voltage (U).
5. To change the measurements shown on a page, use the arrow keys and move the cursor to an on-screen parameter, and select the desired measurement from the soft-keys on the right of the display.
6. To add or remove a page press the “INSERT PAGE” or “DELETE PAGE” respectively. 1 to 5 pages are supported.

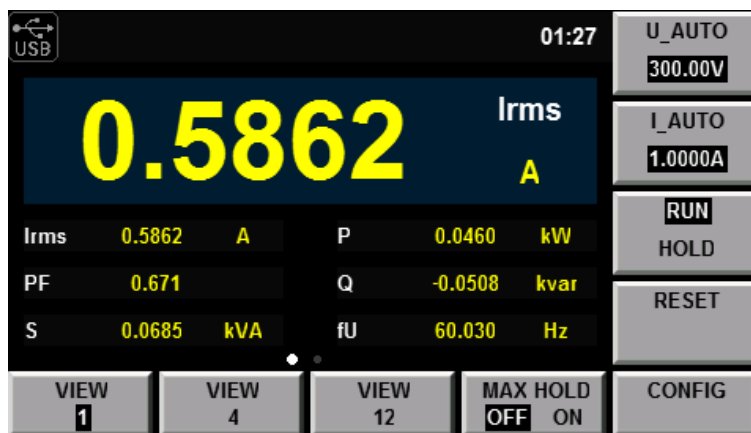

Figure 5.1: 1 main measurement



Figure 5.2: 4 main measurements



Figure 5.3: 12 main measurements

## Chapter 6

# Waveform Display Function

The 5335B power meter displays waveform representations of the sampled data measured. This function is designed to be similar to an oscilloscope with many of the typical functions of oscilloscopes available, like trigger, run/stop and single trigger. The capture of data is not limited to that displayed onscreen, the measurement interval is also involved. For example, measuring a 15Hz signal with the interval set to 0.1s does not allow for stable measurement of the frequency. The waveform is however still viewable.

### 6.0.1 Introduction of soft keys on the interface

To enter the waveform function press the  button.

Introduction of waveform display interface

The trigger status is described as follows:

Parameter name	Parameter descriptions
V_RANGE	Voltage range setting: press to set the voltage range
A_RANGE	Current range setting: press to set the current range
RUN/STOP	Run/stop: press to run or stop waveform capture
SINGLE	Single measurement: pressing this stops capture and proceeds with a single capture of data following a trigger event.
SCOPE(U/A/UA)	Select the waveform to be displayed on the screen: voltage/current/voltage and current.
KNOB SEL (U/A/TL/TD/Td)	Knob selection: the following variables can be adjusted by rotating the knob: vertical voltage position/vertical current position/trigger level/trigger delay/level calibration.
AUTO	Automatic adjustment: when the soft key corresponding to this parameter is pressed, the power meter will automatically calibrate the input signal to display the best effect of the input signal.
TRIG SET	Trigger setting
MEASURE SET	Measurement setting

Table 6.1: Waveform Display Parameters

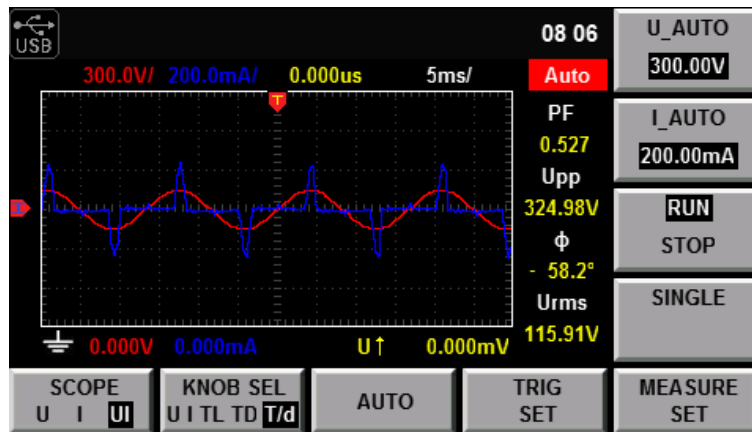

Figure 6.1: Waveform Display Details

Trigger status	Instruction
Auto	When the trigger mode is set as Auto, the trigger status Auto will be displayed after triggering.
Auto?	When the trigger mode is set as Auto, the trigger status will be Auto in the case of no triggering?
Trig	When the trigger mode is set as Normal, the trigger status Trig will be displayed after triggering.
Trig?	When the trigger mode is set as Normal, the trigger status will be Trig in the case of no triggering?
Stop	When the “Stop” soft key in the waveform display interface is pressed, the trigger status Stop will be displayed.

Table 6.2: Trigger Statuses

## 6.0.2 Vertical calibration

When the crest factor CF is 3, the selected voltage range and current range will be subject to vertical calibration (voltage/grid, current/grid). When CF is 6, the selected voltage range and current range will be subject to two-time vertical calibration (voltage/grid, current/grid).

## 6.0.3 Horizontal calibration

When the “KNOB SEL” soft key is pressed and “T/d” is selected, horizontal calibration (scanning speed) adjusted by rotating the knob. In this case, time/grid information changes can be observed on the screen by rotating the knob and changing the horizontal (time/grid) setting. When acquisition is run, the sampling rate can be changed by adjusting the horizontal calibration knob. When acquisition is stopped, sampling data can be amplified by adjusting the horizontal calibration knob.

## 6.0.4 Trigger delay

When the KNOB SEL soft key is pressed and “TD” is selected, the trigger delay can be adjusted by rotating the knob. In this case, when the knob is rotated, the trigger point will move horizontally and the delay time will be displayed on the screen. When the delay time is changed, the trigger point ( ) will move horizontally, and the

distance between the trigger point and the horizontal center will be indicated. The trigger point is displayed along the top of the display grid.

### 6.0.5 Trigger waveform

When the specified trigger conditions are satisfied, the trigger waveform will be displayed, and the triggering time point is called trigger point. The trigger point is generally displayed in the left of the display screen. Following the trigger point, the waveform is displayed on the display screen from left to right over time. Before using the trigger function, the user needs to configure the following parameters:

**Trigger mode** The trigger mode refers to conditions for updating the contents displayed on the screen. Including the Auto mode and Normal mode Auto mode: the displayed waveform is updated in case of triggering in the pause time and automatically updated in case of no triggering in the pause time. Normal mode: the displayed content is updated in case of triggering and not updated in case of no triggering.

**Trigger source** The trigger source is used for generating triggering conditions. The user can select the trigger source from the input signal of the input unit and the external clock signal.

**Trigger slope** The slope refers to signal changes from low level to high level (rising edge) or from high level to low level (descending edge). When used as a triggering condition, the slope is called trigger slope.

**Trigger level** Level of trigger slope: triggering occurs when the level of the signal of the trigger source reaches the set trigger level under the specified trigger slope conditions. When the “KNOB SEL” soft key is pressed and “TL” is selected, the trigger level can be adjusted by rotating the knob. In this case, the trigger level can be changed by rotating the knob, and changes in the trigger level can be observed on the screen.

## 6.1 Adjustment of Measurement Parameters

You can rotate the knob to adjust the vertical calibration, horizontal calibration, trigger delay and trigger level of the waveform display interface. Detailed steps are as follows:

### 6.1.1 Operation steps

1. Press  to enter the waveform display interface.
2. In the waveform display interface Press the soft key corresponding to the “KNOB SEL” parameter and select the parameter to be adjusted. When “KNOB SEL” is pressed once, the parameter to be adjusted via the knob will be switched in sequence among U/A/TL/TD/Td.
3. When the parameter is adjusted by rotating the knob, the interface will display changes of the corresponding value.

## 6.2 Setting of Trigger Configuration

When you need to enable the trigger function, you should select the trigger source, trigger mode, trigger slope and other trigger-related configuration. Detailed steps are as follows:

Operation steps

1. Press  to enter the waveform display interface.

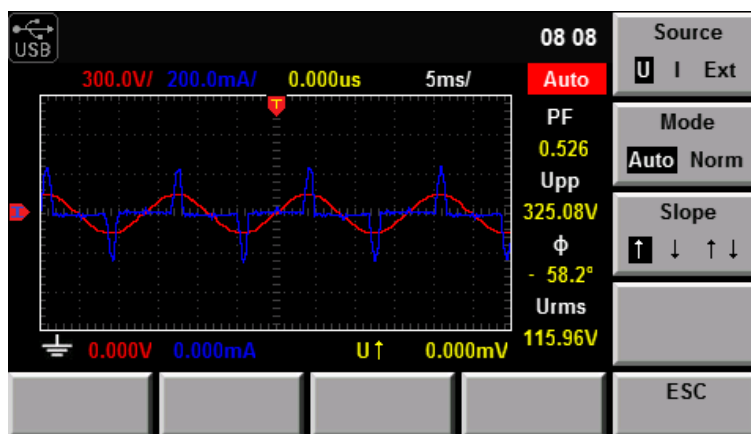

Figure 6.2: Trigger Setup Screen

Projects	Specification
Interface type	BNC interface
Input level	TTL
Minimum pulse width	$1\mu s$
Trigger delay time	Within ( $1\mu s + 3$ sampling cycles)

Table 6.3: External Trigger Input Specifications

2. In the waveform display interface Press the soft key corresponding to the “TIRG SET” parameter to enter the trigger setting interface, as shown below.
3. Press the right soft key corresponding to the parameter to select the required trigger configuration.

**Source** trigger source

**Mode** trigger mode

**Slope** trigger slope

### 6.2.1 External trigger input (Ext)

When the trigger source is set as Ext, input the trigger signal into the external signal input interface (Synchronous) of the rear panel according to the following specifications.

**NOTE:** When the voltage higher than 0-3.3V is applied on the external signal input interface (Synchronous), the instrument may be damaged.

**Minimum pulse width** refers to the width of the high or low trigger level, at least  $1\mu s$ .

**Trigger delay time** refers to the delay between the appearance of the trigger level and the response of CPU, within ( $1\mu s + 3$  sampling cycles).

## Chapter 7

# Harmonic Measurement Function

This chapter describes the features and use of the harmonic measurement function of the 5335B power meter in details.

### 7.1 Basic Concepts

With the 100kHz bandwidth, the 5335B power meter can realize harmonic measurement of high speed and wide dynamic range. The voltage, current, active power, reactive power and phase of harmonics and total harmonic distortion (THD) factor can be tested in the harmonic mode. In addition, the 5335B power meter can be used for multiple harmonic measurements, 50-order harmonics of the fundamental frequency at most.

The 5335B power meter displays harmonic parameters in the list or bar chart form so as to provide clear analysis of test results.

Introduction of soft keys on the interface

Select the !@!@! button, and the initial harmonic measurement interface below will appear.

Description of information of harmonic measurement interface:

Parameter name	Parameter descriptions
V_RANGE	Voltage range setting: press the soft key corresponding to this parameter to set the voltage range.
A_RANGE	Current range setting: press the soft key corresponding to this parameter to set the current range.
RUN/HOLD	RUN/HOLD: press the soft key corresponding to this parameter to run/hold the harmonic status.
RESET	Reset.
FUNC(W/A/V)	Function options (power/current/voltage)
BAR	Displayed in the bar chart form
LIST	Displayed in the list form
SETUP	Parameter setting.

Table 7.1: Harmonic Measurement Parameters

### 7.1.1 Introduction of harmonic information

When the “BAR” button is selected in the harmonic measurement interface, the bar chart of harmonic measurement results will be displayed. The bar chart is used for displaying the percentage of different harmonics. Harmonics can be displayed in the whole sequence, odd sequence and even sequence. The following is the whole-sequence harmonic bar chart.

Description of interface information:

Total harmonic parameter: including the total harmonic distortion (THD) factor and total harmonic content. When different measurement functions are selected, different harmonic parameters will be displayed. When the soft key corresponding to the “FUNC” parameter is pressed, different measurement functions can be selected. W/A/U can be selected as the measurement function in sequence when this button is pressed once. Parameter meanings of different functions are as follows:

**Power (W)** total harmonic distortion rate of power and total harmonic power

**Current (A)** total harmonic distortion rate of current and total harmonic current

**Voltage (U):** total harmonic distortion rate of voltage and total harmonic voltage

Single-order harmonic parameters: displaying the frequency, harmonic content, harmonic distortion factor and phase of single-order harmonics. The user can rotate the knob to select the single-order harmonics to be displayed. The selected harmonics are displayed in red in the bar chart form.

Description of harmonic list interface

When the “LIST” button is selected in the harmonic measurement interface, the list of harmonic measurement results will be displayed. This list is used for showing the voltage, current, active power, reactive power, phase and total harmonic distortion (THD) factor of different harmonics. Harmonic lists can be displayed in the whole sequence, odd sequence and even sequence. Below is a whole-sequence harmonic list.

Harmonic content: this list is used for showing all harmonic contents of single-order harmonics, including the voltage, current and power. You can view other harmonic parameters by operating the Left/Right button to turn pages. In this case, the line scroll bar and current page are shown in bright white circles. Measurement parameters are described in the following table:

Harmonic order list: this LIST can show the data of one-order to 50-order harmonic signals. These data can be displayed in the whole sequence, odd sequence and even sequence. The rows which are not displayed, i.e. single-order harmonic data which are not displayed, can be presented by operating the Up/Down button. In this case, the row scroll bar and current page in displayed in bright blue bars.

## 7.2 Setting of Harmonic Measurement Configuration

You can set the distortion factor calculation formula, PLL source, harmonic sequence and harmonic analysis times of harmonic measurement. Specific steps are as follows:

Operation steps

1. Press  to enter the harmonic measurement interface.
2. Press the soft key corresponding to the “SETUP” parameter in the harmonic measurement display interface to enter the harmonic parameter configuration interface. Press the “ ” button to select the required parameter, as shown in Figure 7.1.



Abbreviations	Instruction
U(V)	Voltage
$\phi_{UI}(\circ)$	Phase difference of k-order harmonic voltage and harmonic current
A(mA)	Current
$\phi_{UU}(\circ)$	Phase difference of harmonic voltage U(k) and fundamental wave U(1)
W(W)	Active power
$\phi_{II}(\circ)$	Phase difference of harmonic current I(k) and fundamental wave I(1)
S(VA)	Apparent power
U(%r)/ U(%f)	Harmonic distortion factor of voltage
Q(var)	Reactive power
A(%r)/ A(%f)	Harmonic distortion factor of current
$\lambda()$	Power factor
W(%r)/W(%f)	Harmonic distortion factor of active power

Table 7.2: Measurement Parameters

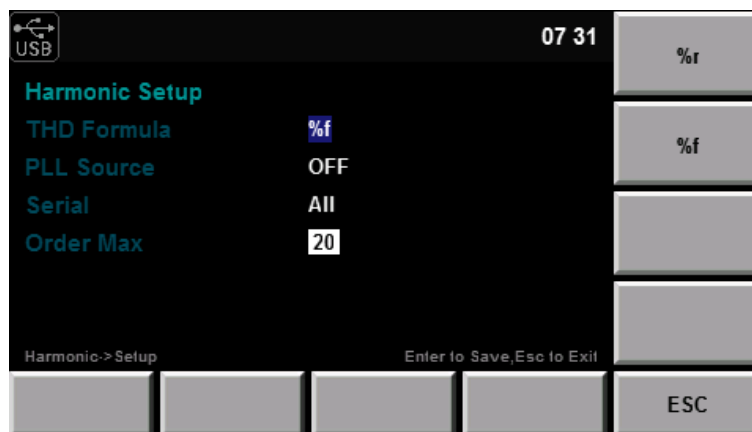

Figure 7.1: Harmonic Measurement Setup Menu

### 7.2.1 Parameter descriptions:

Distortion factor calculation formula:

The following two formulas can be selected for calculation of the distortion factor.

**%r** using all harmonic measurement data from the minimum harmonic order (0) to the maximum harmonic order (within the upper limit of analysis orders) as the denominator.

**%f** using the data of fundamental wave (1-order) components as the denominator.

Parameters	Instruction
THD Formal	Distortion factor calculation formula. % r: displaying harmonics in the form of percentage to the overall current (voltage, power) amplitude of all harmonics. % f: displaying harmonics in the form of percentage to the fundamental wave current (voltage, power).
PLL Source	Select the PLL (Phase Locked Loop) source: U/I/OFF. Used for determining the fundamental wave cycle as the reference for analysis of harmonic orders.
Serial	Harmonic sequence: whole sequence/odd sequence/even sequences
Order Max	Set the harmonic analysis orders (1-50). You can specify the harmonic measurement range. These specified analysis orders are used for calculating the value of the distortion factor.

Table 7.3: Harmonic Parameters

The distortion factor calculation formulas and methods of different measurement functions are as follows:

$$\text{Measurement function} \quad \%r \quad \%f \quad (7.1)$$

$$\text{Harmonic distortion factor of voltage} \quad \frac{U(k)}{U(\text{total})} \quad \frac{U(k)}{U(1)} \quad (7.2)$$

$$\text{Harmonic distortion factor of current} \quad \frac{I(k)}{I(\text{total})} \quad \frac{I(k)}{I(1)} \quad (7.3)$$

$$\text{Harmonic distortion factor of active power} \quad \frac{P(k)}{P(\text{total})} \quad \frac{P(k)}{P(1)} \quad (7.4)$$

$$\text{Total harmonic distortion rate of voltage} \quad \frac{\sqrt{\sum_{k=2}^{\text{max}} U(k)^2}}{U(\text{total})} \quad \frac{\sqrt{\sum_{k=2}^{\text{max}} U(k)^2}}{U(1)} \quad (7.5)$$

$$\text{Total harmonic distortion rate of current} \quad \frac{\sqrt{\sum_{k=2}^{\text{max}} I(k)^2}}{I(\text{total})} \quad \frac{\sqrt{\sum_{k=2}^{\text{max}} I(k)^2}}{I(1)} \quad (7.6)$$

$$\text{Total harmonic distortion rate of active power} \quad \left\| \frac{\sqrt{\sum_{k=2}^{\text{max}} P(k)^2}}{P(\text{total})} \right\| \quad \left\| \frac{\sqrt{\sum_{k=2}^{\text{max}} P(k)^2}}{P(1)} \right\| \quad (7.7)$$

**NOTE** Total harmonics are calculated as follows:  $U(\text{total}) = \sqrt{\sum_{k=0}^{\text{max}} U(k)^2}$ ,  $I(\text{total}) = \sqrt{\sum_{k=0}^{\text{max}} I(k)^2}$ ,

$P(\text{total}) = \sum_{k=0}^{\text{max}} P(k)$ . k indicates the harmonic order, and max indicates the upper limit of analysis orders. max is determined by the frequency of PLL source automatically, 50 orders at most.

### 7.2.2 PLL source

In the harmonic mode, 5335B adopts PLL to multiply the frequency of the input signal. The frequency multiplication output signal is used as the A/D sampling clock in the instrument so as to achieve the purpose of synchronous sampling. Therefore, the frequency of the signal of the PLL source can determine the A/D sampling clock in the instrument. However, the quality of the signal of the PLL source may affect the stability and accuracy of sampling data.

### 7.2.2.1 PLL source selection

The voltage or current of the input unit can be selected as the PLL source. Used for determining the fundamental wave cycle as the reference for analysis of harmonic orders. The fundamental wave frequency of the PLL source is 10Hz to 1.2kHz.

### 7.2.2.2 Considerations for selection of PLL source

Please select the signal with the same cycle as that of the harmonic measurement object signal. In order to stably measure harmonics, select the input signal with little distortion as the PLL source. If the fundamental wave frequency of the PLL source changes or the fundamental wave frequency cannot be measured as a result of waveform distortion, accurate measurement results may not be obtained. When the test object is a switch type power supply and the voltage signal is subject to less distortion than the current signal, it is recommended to use the voltage as the PLL source.

### 7.2.2.3 Signal level of PLL source

If the amplitude level of the signal input into the unit as the PLL source is small relative to the range, synchronization with PLL will fail. If the crest factor is set as 3, the amplitude level of the PLL source should exceed 50% of the range at least during setting of the range. If the crest factor is set as 6, the amplitude level of the PLL source should exceed 100% of the range at least during setting of the range.<sup>1</sup>

When the fundamental wave frequency is lower than 440Hz and contains high-frequency components, it is recommended to turn on the frequency filter. This filter only applies to the frequency measurement circuit.

If the frequency of the PLL source changes, the correct measured value will be displayed after data are updated several times. The frequency of the PLL source needs to be tested again via the PLL circuit in the instrument in case of changes of the PLL source or its frequency, the correct measured value cannot be obtained at once.

## 7.2.3 Harmonic analysis order

The harmonic analysis order  $k$  is an integer number ranging from 0 to the upper limit of analysis orders. Zero indicates the DC component. The upper limit of analysis orders is automatically determined by the frequency of the PLL source. The upper limit of harmonic analysis orders can be determined automatically or set manually. Take the smaller value. 50 orders at most The relationship between the upper limit of harmonic analysis orders and the fundamental wave frequency of the PLL source is shown in the table below.

PLL fundamental frequency	Sampling rate	Window width	Harmonic order upper limit
10Hz – 75Hz	$f \cdot 1024$	1	50
75 Hz – 150 Hz	$f \cdot 512$	2	32
150 Hz – 300 Hz	$f \cdot 256$	4	16
300 Hz – 600 Hz	$f \cdot 128$	8	8
600 Hz – 1200 Hz	$f \cdot 64$	16	4

**NOTE** The upper limit of analysis orders may be reduced.

**NOTE** If the analysis window determined by the fundamental wave frequency of the PLL source is longer than the data updating cycle, no harmonic data will be detected. In this case, the data updating cycle should be reduced. For example, when the fundamental wave frequency of the PLL source is 10Hz (cycle: 100ms), the analysis window

<sup>1</sup>When the fundamental wave frequency is no more than 200Hz, the frequency filter must be turned on.

is one-wave long, and the data measurement interval is 100ms. In this case, the harmonic measurement time is approximately morethan or equal to 150ms (data measurement interval and data processing time). Therefore, please select the data updating rate of 250ms or more for measurement and display of harmonic data.

## Chapter 8

# Integral Operation Function

This chapter describes the features and use of the integral function of the 5335B power meter in details.

### 8.1 Basic Concepts

The 5335B power meter can be used for integral operation of the current and power of the input unit. Technical indicators can be calculated. In addition, the range can be switched automatically in the Buy and Sell modes according to the input level so as to accurately complete integrate measurement.

During operation of the air-conditioner, refrigerator, induction cook and other household appliances, the working status will change frequently, resulting in changes of the working current in a large scale. The current may decrease of dozens of amperes to a few milliamperes. Ordinary power measuring instruments can only be used for integral measurement within one range. If the measured value exceeds the current maximum range, the measurement result is inaccurate. You need to manually switch the range before integral measurement. Integral measurement of equipment subject to large current changes cannot be performed continuously. The IT9120 series power meter can automatically switch the range in the integral mode. Therefore, errors of integral measurement caused by manual range switching can be eliminated, and the power consumption of household appliances can be measured more accurately. See the schematic diagram below.

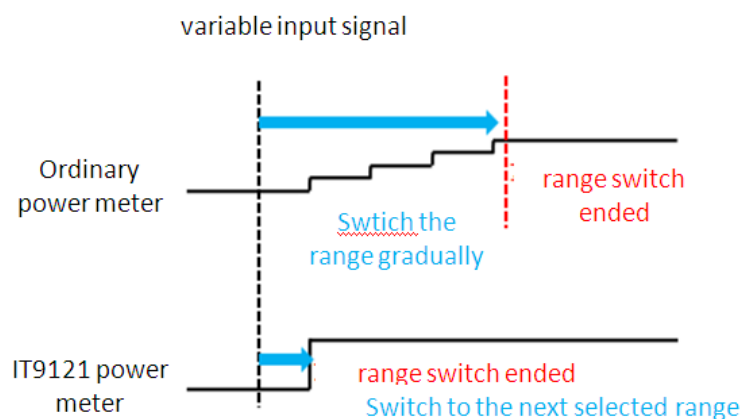

Figure 8.1: Range Switching

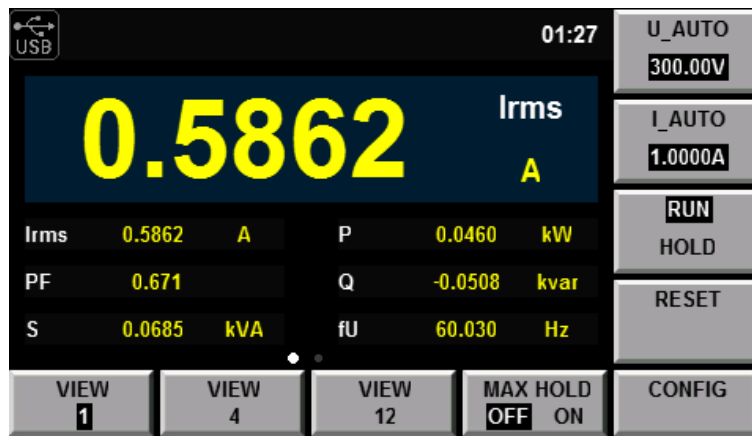

Figure 8.2: Meter Display

Parameter name	Parameter descriptions
V_RANGE	Voltage range setting: press the soft key corresponding to this parameter to set the voltage range.
A_RANGE	Current range setting: press the soft key corresponding to this parameter to set the current range.
RUN/HOLD	Run/hold: press the soft key corresponding to this parameter to run or hold the integral function.
RESET	Reset.
FUNC(w/q/AV)	Selection of the integral function: active power integral (W), current integral (q) and average active power integral (AV).
LARGE(WP/WP+/WP-, q/q+/q-, WPAV)	Selection of the item to be displayed in a amplified manner: WP (watt hour, the sum of positive and minus watt hours), WP+ (the consumption of positive watt hours), WP- (the negative watt hours of feedback power), q (ampere hour, the sum of positive and negative Ampere hours), q+ (the consumption of positive Ampere hours), q- (the negative ampere hours of feedback power) and WPAV (average active powerintegral).
START	Integral Start button In the manual start mode, the integral function can be enabled by pressing the soft key corresponding to this parameter.
STOP	Integral Stop button In the manual stop mode, the integral function can be disabled by pressing the soft key corresponding to this parameter.
SETUP	Set relevant parameters of integral measurement.

Table 8.1: Integral Measurement Soft Keys

## 8.2 Introduction of soft keys on the interface

When the “Integ” button is pressed, the initial integral measurement interface below will appear.

Description of information of integral measurement interface:

## 8.3 Integral measurement display information

Description of measurement information:

Character	Function description
Mode	Display the integral start and stop mode. Start mode: MANUAL and TIME Stop mode: MANUAL, TIME and TInterval.
State	Display the current status of the integral function.
Start:	displayed when the integral function is working.
Stop:	displayed when the integral function is interrupted, canceled or stopped.
Ready:	displayed in the ready state of the real-time start mode.
Time Up:	displayed when it reaches the specified time of the integral timer.
Reset:	displayed when the integral value and integral time are reset via integral resetting.
Error:	when the power supply is recovered, the integral function is stopped and the integral result before power failure is displayed. This integral state is called Error state.
Time	Display the integral time.
St	Display the set integral time.
Et	Display the set integral ending time.
Timer	Display the fixed integral time.

Table 8.2: Measurement Information

### 8.3.1 Integral operation

- Active power integral  
In watt hour, displayed as WP (watt hours, the sum of positive and negative watt hours), WP+ (the consumption of positive watt hours) and WP- (the negative watt hours of feedback power).
- Current integral  
In q, displayed as q (ampere hours, the sum of positive and negative ampere hours), q+ (the consumption of positive ampere hours) and q- (the negative ampere hours of feedback power)
- Average active power integral  
In watt, displayed as WPAV (average active power integral)
- Integration time  
Displayed as Time, in the format of hhhh:mm:ss.

## 8.4 Specification

- Save in case of power failure  
The integral result can be kept in the memory even in case of power failure during operation of the integral function. When the power supply is recovered and the integral function is disabled, the integral result before power failure is displayed. When the power supply is recovered and the integral is rest, the integral function is enabled again.
- Display resolution  
The maximum display resolution of the integral value is 99999. When the integral value reaches 100000, the decimal point will move automatically. For example, when 0.01mwh is added to 999.99mwh, 1.0000wh will be displayed.
- Display in case of overflow  
When the integral value meets the following overflow conditions, the integral function will be disabled, and the integral time and integral value at this point will be kept.

Function	Integral resetting	Current integral status	Integral interruption
Functions related to settings of measurement parameters			
Wiring	Executable	Unenforceable	Unenforceable
Measurement range	Executable	Unenforceable	Unenforceable
Filter	Executable	Unenforceable	Unenforceable
Averaging function	Executable	Unenforceable	Unenforceable
Synchronization	Executable	Unenforceable	Unenforceable
Data updating rate	Executable	Unenforceable	Unenforceable
Integral function parameter setting			
Integral mode	Executable	Unenforceable	Unenforceable
Integral timer	Executable	Unenforceable	Unenforceable
Integral operation			
Integral start	Executable	Unenforceable	Executable
Integral stop	Unenforceable	Executable	Unenforceable
Integral resetting	Executable	Unenforceable	Executable
Other operations			
Save operation	Executable	Executable	Executable
Hold operation	Executable	Executable	Executable
Single measurement operation	Executable	Executable	Executable

Table 8.3: Settings configurability per mode

- The integral time reaches the maximum value (10000 hours).
- The integral values of WP, q and WPAV reach the maximum/minimum display integral values.
- Maximum/minimum display integral value
  - Active power integral (WP):  $\pm 99999$  Mwh
  - Current integral (q):  $\pm 99999$  MAh
  - Average power integral (WPAV):  $\pm 99999$  Mw
- Restricted implementation  
Settings of the following functions cannot be changed during integral operation.

**NOTE** In addition to the above items, other settings (such as self-testing and date/time setting) or operations with influence on the integral cannot be executed; otherwise, errors may be caused.

## 8.5 Setting of Integral Measurement Configuration

You can set the start mode, stop mode, automatic zero setting, automatic calibration, watt-hour integration, current integration and other parameters of integral measurement. Specific steps are as follows:



### Operation steps

1. Press “Integ” to enter the integral measurement interface.
2. Press the soft key corresponding to the “SETUP” parameter in the integral measurement interface to enter the integral parameter configuration interface. Press the “ ” button to select the required parameter, as shown in the figure below.

#### 8.5.1 Parameter descriptions:

**Start** set in the MANUAL mode or TIME mode via the right soft key.

**MANUAL** press the “START” soft key in the integral measurement interface in the manual start mode to trigger the manual start of the integral function.

**TIME:** the date on which the integral mode is started can be set in the real-time start mode. Integration will be started on the set date. When the time/date combination is set in the real-time start mode, integration will not be started before the current time and date. Integration will be started when the screen is updated once at least before the start time.

**Stop:** set in the MANUAL mode, TIME mode and TInterval mode via the right soft key.

**MANUAL:** press the “STOP” soft key in the integral measurement interface in the manual stop mode to manually stop integration. When the integration time reaches the maximum integration time (10,000 hours) or the integral value reaches the maximum/minimum display value, integration will be stopped, and the current integral time and integral value will be kept.

**TIME** The date for stop of the integral mode can be set in the real-time stop mode. Integration will be stopped on the set date. When it reaches the set time or the integral value reaches the maximum/minimum display integral value, integration will be stopped, and the current integral time and integral value will be kept.

**TInterval** the integral measurement time can be set in the set-time stop mode. When it reaches the set ending date and time or the integral value reaches the maximum/minimum display integral value, integration will be stopped, and the current integral time and integral value will be kept.

**Auto Clear** used for enabling (ON) or disabling (OFF) the function of automatic zero clearing of the integral. On: integration is restarted when the START button is pressed to start integration. OFF: integration is restarted based on the integral value at the end of previous integration when the START button is pressed to start integration.

**Auto Cal** used for enabling (ON) or disabling (OFF) the function of automatic integral calibration. When automatic integral calibration is enabled, zero setting is implemented. In this case, the power and current measured just now are subject to integration.

**WP type** used for selecting the integral mode for positive and negative watt hours. There are four integral modes:

**Charge/Discharge:** used for measuring the DC positive and negative watt hours (integration of sampling data).

**Sold/Bought** used for measuring the AC positive and negative watt hours (value integration in each data updating cycle).

**q type** used for selecting the current integration mode. Options of the current integration mode are as follows:

**rms** Effective value;

**mn** Calibration to the average rectified value of the effective value.

**dc** Simple averaging;

**rmn** Average rectified value;

**ac** AC component

## 8.6 Integration

When the integral measurement function is enabled, you can keep the current integral information and carry out the following operations: exit, start and stop. Specific steps are as follows:

Operation steps

1. Press “Integ” to enter the integral display interface.
2. In the integral measurement display interface Press the soft key corresponding to the “START” parameter to start or recover integral operation. The Start status and integral operation value are displayed in the interface.
3. When you need to keep the current integral status and integral result, you can press the soft key corresponding to the “RUN HOLD” parameter. Then the current status of the integral result display and communication output will be kept no matter whether integral operation is running.
4. When you need to continue to implement integral operation, double-press the soft key corresponding to the “RUN HOLD” parameter to exit the HOLD status. The power meter will display the integral result after exiting the HOLD status. The schematic diagram of display of the HOLD/RUN integral result is shown below.
5. When you need to suspend integral operation, press the soft key corresponding to the “Stop” parameter to suspend integral operation.
6. Press the soft key corresponding to the “RESET” parameter to reset the integral value and integral time. The relationship diagram of start, suspension and resetting of the integral operation status is shown below.

**Auto Clear** when ON is selected.

**Auto Clear** when OFF is selected.

## Chapter 9

# Remote Operation

There are four types of communication interfaces available: USB, Ethernet, GPIB and RS232. You can choose any one of them to communicate with a PC.

### 9.1 RS-232 Interface

RS232 interface: use a cable with two COM interface (DB9) to connect power meter and PC. It can be activated by menu key on the front panel. All SCPI commands are available through RS-232 programming.

- RS-232 data format The RS-232 data is a 10-bit word with one start bit and one stop bit. The number of start and stop bits is not programmable.
- Baudrate Available baudrate: 4800 9600 19200 38400 57600 115200
- RS-232 connection The RS-232 serial port can be connected to the serial port of a controller (i.e., personal computer) using a straight through RS-232 cable terminated with DB-9 connectors. Do not use a null modem cable. Table 9.1 shows the pinout for the connector.

If your computer uses a DB-25 connector for the RS-232 interface, you will need a cable or adapter with a DB-25 connector on one end and a DB-9 connector on the other, wired straight through (not null modem).

RS-232

#### 9.1.1 RS-232 troubleshooting

If you are having trouble communicating over the RS-232 interface, check the following: The computer and the power meter must be configured for the same baudrate, parity, number of data bits, and flow control options. Note that the electronic load is configured for 1 start bit and 1 stop bit (these values are fixed). The correct interface

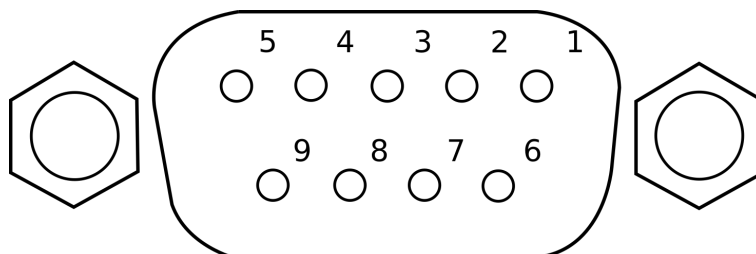

Figure 9.1: RS-232 DE-9 Connector

Pin #	Signal
1	NC
2	TX
3	RX
4	NC
5	GND
6	NC
7	CTS
8	RTS
9	NC

Table 9.1: RS-232 (DE-9) Pinout

cables or adapters must be used, as described under RS-232 connector. Note that even if the cable has the proper connectors for your system, the internal wiring may be incorrect. The interface cable must be connected to the correct serial port on your computer (COM1, COM2, etc.).

### 9.1.2 RS-232 Communication settings

Before communication operation, please make sure that the following parameters of electronic load match that of PC. Baud rate :9600(4800,9600,19200,38400,57600,115200). You can enter system menu through panel to set communication baud rate. Data bit:8 Stop bit:1 Parity:(none,even,odd) EVEN:: eight data bits with even parity ODD::eight data bits with odd parity NONE: : eight data bits without parity

Start Bit 8 Data Bits Parity=None Stop Bit

## 9.2 USB interface

Use Type A to Type B USB cables to connect the power meter.

The USB interface capabilities of the power meter are described below:

- The interface is IEEE488.2 standard USB488 interface
- The interface accepts REN\_CONTROL, GO\_TO\_LOCAL , LOCAL\_LOCKOUT request.
- The interface accepts MsgID = TRIGGER USBTMC command message and forwards TRIGGER requests to the function layer.

The USB488 device capabilities of the power meter are described below:

- The device understands all mandatory SCPI commands.
- The device is SR1 capable.
- The device is RL1 capable.
- The device is DT1 capable.

### 9.3 GPIB interface

First connect GPIB port of power meter to GPIB card of PC. They must be sufficient contact and tighten the screws. And then set address. The address can be set from 0 to 30.

### 9.4 LAN interface

Use a network cable to connect PC through LAN interface of the power meter.

- IP mode  
MANU: manually set IP address, subnet mask, default gateway, etc.  
DHCP (Dynamic Host Configuration Protocol)  
DHCP refers to a protocol that temporarily assigns necessary information to PCs connected to the Internet. If the network is provided with an available DHCP server, the server will automatically assign information (IP address, subnet mask and default gateway) to PCs and other equipment connected to the network. IT9121 cannot use DHCP unless the network is provided with a DHCP server. Please ask your network administrator DHCP if DHCP is available.
- IP Address  
IP addresses assigned to IT9121 can be set. Default address is 192.168.000.000.
- IP address refers to ID assigned by the network to each equipment (Internet or enterprise Intranet).
- IP address refers to four 32-bit values within 0 - 255 which are separated by decimal points, such as [192.168.111.24].
- Please ask the network administrator to provide an IP address.
- Use DHCP network to automatically set the IP address.
- Subnet masksetting  
The mask used when subnet website is determined from an IP address may be set. Default address is 255.255.255.255.
- Vast TCP/IP networks like Internet are often divided into several small networks, i.e. subnets. The subnet mask is used to identify how many digits of the 32-digit values in the IP address belong to the subnet address. The part beyond the network address is used to identify the host number of each PC connected to the network.
- Ask your network administrator about values of subnet mask.
- Use DHCP network to automatically set the subnet mask.
- Gatewaysetting  
IP address of gateway may be set to communicate with equipment in other network (default gateway). Default address is 192.168.000.000.
- The default gateway controls data exchange between networks and protocols to ensure smooth data transmission.
- Ask your network administrator about values of default gateway. It is possible that the setting is unnecessary.  
Use DHCP network to automatically set the default gateway.

## Chapter 10

# Specifications

The specifications listed below are valid and specified for the following conditions:

- Warm up time of 30 minutes
- Ambient temperature -  $23 \pm 5^{\circ}$
- Relative humidity 30 to 75%

## Specifications

Specifications are subject to the following conditions

Temperature: 23±5° C, humidity: 30 to 75% RH.

Warm-up time: 30 minutes

Model	5335B	
<b>General Measurement Specifications</b>		
Basic measurements	Voltage, Current	Peak to peak, Maximum, Minimum, Average_rms, Average_rectified, DC, Crest factor (current), Inrush (current)
	Power	Real, Apparent, Reactive, DC, Power factor
	Time	Frequency, Phase
	Integration	Total power, Total current, Maximum power, Minimum power
Harmonic measurements	Type	Current, Voltage, Real power, Apparent power, Reactive power, Power factor, Phase, Percentage of total (Current, Voltage, Power)
	Range	DC up to 50 <sup>th</sup> order
	Max. Frequency	100 kHz
Input bandwidth	DC, 0.5 Hz to 100 kHz	
Measurement method	Digital sampling	
A/D Converter	Simultaneous conversion of voltage and current inputs, Resolution: 18-bit, Maximum conversion rate: 10 μs	
Line filter	Select OFF or ON (cutoff frequency at 500 Hz)	
Peak (max,min)	Voltage, current, or power	
Input voltage continuous max.	1.5 kV-peak or 1 kV-RMS, whichever is less	
Input voltage transient (<1s) max.	2 kV-peak or 1.5 kV-RMS, whichever is less	
Input voltage common-mode max.	600 Vrms	
Voltage input impedance	2 MΩ + 13 pF in parallel (typical)	
Current input impedance (typical)	5 mA to 200 mA range	505 mΩ + 0.1 μH
	0.5 A to 20 A range	5 mΩ + 0.1 μH
	Sensor input	20 kΩ (50 mV to 2 V) 100 kΩ (2.5 V to 10 V)
Input current continuous max.	5 mA to 200 mA range	30 A-peak or 20 A-RMS, whichever is less
	0.5 A to 20 A range	100 A-peak or 30 A-RMS, whichever is less
	Sensor input	Peak value less than or equal to 5 times the rated range
Input current transient (<1s) max.	5 mA to 200 mA range	30 A-peak or 20 A-RMS, whichever is less
	0.5 A to 20 A range	150 A-peak or 40 A-RMS, whichever is less
	Sensor input	Peak value less than or equal to 10 times the rated range
<b>Voltage Measurement Accuracy and Ranges</b>		
Ranges	CF=3: 15 V, 30 V, 60 V, 150 V, 300 V, 600 V CF=6: 7.5 V, 15 V, 30 V, 75 V, 150 V, 300 V	
Accuracy <sup>2</sup> (line, frequency, & digital filter set to off)	DC to 1 kHz	±(0.1% + 0.2% F.S.)
	1 kHz < f ≤ 10 kHz	±((0.07 f <sup>1</sup> )% + 0.3% F.S.)
	10 kHz < f ≤ 100 kHz	±(0.5% + 0.5% F.S.) ± [(0.04 × (f <sup>1</sup> - 10))% ]
Temperature coefficient	For temperature changes after zero-level compensation or range change	+ 0.02% F.S. /°C to the DC voltage accuracy
	Influence of self-generated heat caused by voltage input (U is the voltage reading (V))	+ 0.0000001 × U <sup>2</sup> % to the AC voltage accuracy + 0.0000001 × U <sup>2</sup> % + 0.0000001 × U <sup>2</sup> % F.S. to DC current accuracy

<sup>1</sup> Input signal frequency in kHz

<sup>2</sup> Input waveform: Sine wave crest factor: 3, common-mode voltage: 0 V, power factor: 1  
Frequency filter: Turn on when measuring ≤ 200 Hz

## Specifications (cont.)

Current Measurement Accuracy and Ranges							
Direct input range		CF= 3: 5 mA, 10 mA, 20 mA, 50 mA, 100 mA, 200 mA, 0.5 A, 1 A, 2 A, 5 A, 10 A, 20 A					
		CF= 6: 2.5 mA, 5 mA, 10 mA, 25 mA, 50 mA, 100 mA, 250 mA, 0.5 A, 1 A, 2.5 A, 5 A, 10 A					
Sensor input range	External 1	CF = 3: 2.5 V, 5 V, 10 V CF = 6: 1.25 V, 2.5 V, 5 V					
	External 2	CF = 3: 50 mV, 100 mV, 200 mV, 500 mV, 1 V, 2 V CF = 6: 25 mV, 50 mV, 100 mV, 250 mV, 500 mV, 1 V					
Accuracy <sup>2</sup> (line, frequency, & digital filter set to off)	DC to 1 kHz	±(0.1% + 0.2% F.S.)					
	1 kHz < f ≤ 10 kHz	±{(0.07 f <sup>1</sup> )% + 0.3% F.S.}					
	10 kHz < f ≤ 100 kHz	±(0.5% + 0.5% F.S.) ± [(0.04×(f <sup>1</sup> -10))%]					
Temperature coefficient	2.5 to 200 mA	5 μA/V °C (after zero-level compensation, or range change)					
	500 mA to 20 A	500 μA/V °C (after zero-level compensation, or range change)					
	Influence of internal sensor self-heating	+ 0.00013 × I <sup>2</sup> % of reading to the AC current accuracies + 0.00013 × I <sup>2</sup> % of reading + 0.004 × I <sup>2</sup> mA (0.5 to 20 A) or 0.00013 × I <sup>2</sup> % of reading + 0.00004 × I <sup>2</sup> mA (2.5 to 200 mA), add to the DC current accuracy specifications					
Power Measurement Accuracy							
Real power accuracy <sup>2,3</sup> (CF= 3) <sup>4</sup>	DC	±(0.1% + 0.2% F.S.)					
	0.5 Hz ≤ f < 45 Hz	±(0.3% + 0.2% F.S.)					
	45 Hz ≤ f ≤ 66 Hz	±(0.1% + 0.1% F.S.)					
	66 Hz < f ≤ 1 kHz	±(0.2% + 0.2% F.S.)					
	1 kHz < f ≤ 10 kHz	±(0.1% + 0.3% F.S.) ± [(0.067×(f-1))%]					
	10 kHz < f ≤ 100 kHz	±(0.5% + 0.5% F.S.) ± [(0.09×(f-10))%]					
Apparent power (S)	Voltage accuracy + current accuracy						
Reactive power (Q)	Apparent power accuracy + (√(1.0004-PF <sup>2</sup> ) - (√(1-PF <sup>2</sup> ))) × 100%						
Power factor (PF)	±[(PF-PF/1.0002) + abs(cosØ - cos{Ø+sin <sup>-1</sup> (influence from the power factor when PF=0%/100)})] ± 1 digit when voltage and current are at the measurement range rated input						
Phase angle (Φ)	±[abs(Ø - cos <sup>-1</sup> (PF/1.0002)) + sin <sup>-1</sup> {(influence from the power factor when PF=0%/100)}] deg ± 1 digit when voltage and current are at the measurement range rated input						
Temperature coefficient	Same as the temperature coefficient for voltage and current						
Frequency Measurement Accuracy							
Frequency measurement range	Data update interval	0.1 s	0.25 s	0.5 s	1 s	2 s	5 s
	Measurement range	25 Hz ≤ f ≤ 100 kHz	10 Hz ≤ f ≤ 100 kHz	5 Hz ≤ f ≤ 100 kHz	2.5 Hz ≤ f ≤ 100 kHz	1.5 Hz ≤ f ≤ 50 kHz	0.5 Hz ≤ f ≤ 20 kHz
Accuracy	±0.06%			(CF 3 and signal <30% F.S.) or, (CF 6 and signal <60% F.S.), and ≤ 200 Hz with frequency filter on			
Frequency filter	500 Hz low-pass						

<sup>1</sup> Input signal frequency in kHz

<sup>2</sup> Input waveform: Sine wave crest factor: 3, common-mode voltage: 0 V, power factor: 1  
Frequency filter: Turn on when measuring ≤ 200 Hz

<sup>3</sup> When power factor (PF)=0 (apparent power (S)):  
±0.2% of S when 45 Hz ≤ f ≤ 66 Hz  
±{(0.2+0.2×f)% of S} when 0.066 ≤ f ≤ 100 kHz  
When 0<PF<1(phase angle (Φ)):  
(power reading) × [(power reading error %) + (power range %) × (power range/indicated apparent power value) + {tanΦ × (influence when PF=0)}%]  
When the line filter is turned ON:  
45 to 66 Hz: Add 0.3% of reading  
<45 Hz: Add 1% of reading

<sup>4</sup> Accuracy when the crest factor is set to 6, the accuracy is obtained by doubling specified accuracies



## Specifications (cont.)

Harmonic Measurement Parameters					
Measurement method	PLL synchronization				
Frequency range	PLL frequency source range 10 Hz to 1.2 kHz (typical)				
FFT data length	1024				
Window function	Rectangle				
Fundamental frequency (Fund. freq.)	10 Hz to 75 Hz	75 Hz to 150 Hz	150 Hz to 300 Hz	300 Hz to 600 Hz	600 Hz to 1200 Hz
Sample rate	(Fund. freq.) x 1024	(Fund. freq.) x 512	(Fund. freq.) x 256	(Fund. freq.) x 128	(Fund. freq.) x 64
Window width	1	2	4	8	16
Upper limit of analysis orders	50	32	16	8	4
Harmonic Measurement Accuracy (when line filter is off)					
Frequency	10 Hz ≤ f < 45 Hz	45 Hz ≤ f ≤ 440 Hz	440 Hz < f ≤ 1 kHz	1 kHz < f ≤ 2.5 kHz	2.5 kHz < f ≤ 5 kHz
Voltage and current	±0.15% ± 0.35% F.S.	±0.15% ± 0.35% F.S.	±0.20% ± 0.35% F.S.	±0.80% ± 0.45% F.S.	3.05% ± 0.45% F.S.
Power	±0.15% ± 0.50% F.S.	±0.20% ± 0.50% F.S.	±0.40% ± 0.50% F.S.	1.56% ± 0.60% F.S.	5.77% ± 0.60% F.S.
Oscilloscope Function					
Channels	2				
Measurement	Voltage and current				
Bandwidth (-3 dB)	10 kHz				
Sample rate	100 kS/s				
Record length	300 points/channel				
Horizontal scale (Accuracy ±4.0%)	500 us, 1 ms, 2 ms, 5 ms, 10 ms, 20 ms, 50 ms, 100 ms, 200 ms, 500 ms				
Vertical scale ranges (Accuracy ±4.0%)	CF 3	I: 2.5, 5, 10, 25, 50, 100, 250, 500 mA/div, 1 A, 2.5 A, 5 A, 10 A/div, U: 7.5, 15, 30, 75, 150, 300 V/div			
	CF 6	I: 5, 10, 20, 50, 100, 200, 500 mA/div, 1 A, 2 A, 5 A, 10 A, 20 A/div, U: 15, 30, 60, 150, 300, 600 V/div			
Maximum input voltage (DC+AC peak)	1800 V				
Maximum input current (DC+AC peak)	60 A				
Environmental and Safety					
Temperature	Operating: 41 °F to 104 °F (5 °C to 40 °C) Storage: -4 °F to 122 °F (-20 °C to 50 °C)				
Humidity	20% RH to 80% RH (non-condensing)				
Electromagnetic compatibility	IEC 61326				
Safety	IEC 61010-1, EN 61010-1, Measurement 600 V CAT II				
General					
Display	4.3" TFT-LCD display, 480 x 272				
Remote Interfaces	USB, GPIB, RS232, LAN				
Power	100 to 240 VAC, 50 / 60 Hz				
Power Consumption	50 VA max.				
Dimensions (W x H x D)	8.4" x 3.5" x 14" (214.5 mm x 88.2 mm x 354.6 mm)				
Weight	6.2 lbs (2.8 kg)				
<b>Three-Year Warranty</b>					
Standard Accessories	Getting started manual, instruction manual (downloadable), AC power cord, USB type A-to-type B cable, certificate of calibration				

# Chapter 11

## Routine Maintenance

This chapter describes general maintenance items and maintenance methods of the 5335B power meter.

### 11.1 Self-inspection

The 5335B power meter has a self-inspection function. See “Power-on Self-Test” of Chapter 3 “Inspecting the Instrument” of 5335B Installation Instructions for detailed steps of self-inspection.

### 11.2 Error Information References

The 5335B power meter has a detailed error and prompt information function, so as to help the user to easily carry out positioning and measurement during measurement and use. This section describes all error information of the 5335B power meter as well as error causes and disposals. All prompt information is listed.

#### 11.2.1 Prompt Message List

#### 11.2.2 Error information list

Error information	Error information explanation
usb is not detected	<b>Error description</b> No USB peripheral is found. <b>Possible cause</b> No USB peripheral is inserted. <b>Disposal</b> Insert the U disc type USB peripheral and then copy the screen.
Save screen fail	<b>Error description</b> The screen is not saved successfully. <b>Possible cause</b> USB is disconnected. <b>Disposal</b> Reinsert the USB peripheral.

Error information	Error information explanation
Start time is less than current	<p><b>Error description</b> The start time is less than the current time.</p> <p><b>Possible cause</b> The integral setting is incorrect.</p> <p><b>Disposal</b> Reset the integral start time.</p>
End time is less than current	<p><b>Error description</b> The ending time is less than the current time.</p> <p><b>Possible cause</b> The integral setting is incorrect.</p> <p><b>Disposal</b> Reset the integral ending time.</p>
Timer must be larger than zero.	<p><b>Error description</b> The set time must be larger than zero.</p> <p><b>Possible cause</b> The set integral time is not correct.</p> <p><b>Disposal</b> Reset the set integral time.</p>
Harmonic open fail	<p><b>Error description</b> The harmonic function cannot be enabled.</p> <p><b>Possible cause</b> Communication abnormality</p> <p><b>Disposal</b> Check the communication cable.</p>
Integ open fail	<p><b>Error description</b> The integral function cannot be enabled.</p> <p><b>Possible cause</b> Communication abnormality</p> <p><b>Disposal</b> Check the communication cable.</p>
Integ start fail	<p><b>Error description</b> The integral function cannot be started.</p> <p><b>Possible cause</b> Communication abnormality</p> <p><b>Disposal</b> Check the communication cable.</p>
Integ stop fail	<p><b>Error description</b> The integral function cannot be stopped.</p> <p><b>Possible cause</b> Communication abnormality</p> <p><b>Disposal</b> Check the communication cable.</p>

Error information	Error information explanation
Scope openfail	<p><b>Error description</b> The oscilloscope function cannot be enabled.</p> <p><b>Possible cause</b> Communication abnormality</p> <p><b>Disposal</b> Check the communication cable.</p>
Time set fail	<p><b>Error description</b> Time setting fails.</p> <p><b>Possible cause</b> Time setting is illegal.</p> <p><b>Disposal</b> Reset the system time.</p>
Cal zero fail	<p><b>Error description</b> Zero calibration fails.</p> <p><b>Possible cause</b> Communication abnormality</p> <p><b>Disposal</b> Check the communication cable.</p>

Table 11.1: Errors

### 11.3 Daily maintenance

Introduce basic maintenance in daily use of equipment. Such as cleaning, self-maintenance allowed to be performed by the user, etc.

#### 11.3.1 Equipment cleaning

Use dry cloth or slightly wet cloth to gently wipe the equipment. Do not arbitrarily wipe the inside of the instrument. Cut off the power supply before cleaning.

#### 11.3.2 Initialize

When this operation is implemented, the system settings are recovered to the factory default values.

1. Select "SYSTEM > INITIAL" in the "Menu" interface to enter the system initialization interface. See the following figure.
2. Select the menu items to be initialized (blue symbol background) via button. Menu items with characters ## following should be initialized; ## indicates that the items will not be initialized.
3. Press the soft key corresponding to the symbol on the right of the interface to determine whether to initialize this menu item. Or use the soft key " " (for initialization of all menu items) or " " (no initialization for all menu items) in the lower part of the interface.
4. Press the "START" soft key to initialize system settings. Press the ESC to exit.

Prompt information	Explanation of prompt information
Cal Zero is working!	The instrument is calibrating the zero point.
Cal Zero is completed!	The instrument has completed zero point calibration.
Test screen	Self-inspection of LCD screen
Test dsp	Self-inspection of DSP.
Test beep	Self-inspection of the buzzer.
SelfTest is finished!	The instrument has finished the self-test.
Softkey is not available	The current soft key is not available.
Time set ok!	The time setting is completed.
Meter Initialization	Initialization of general measurement
Integ Initialization	Initialization of integral function
Scope Initialization	Initialization of the oscilloscope function
Harmonic Initialization	Initialization of the harmonic function
Inrush Initialization	Initialization of the inrush function
Setup Initialization	Initialization of setup
System Initialization	Initialization of the system
Initialization is finished!	Initialization is finished.
Integ start	Integration is started.
Integ stop	Integration is stopped.
Integ time up	The integral time is up.
Max page has been reached.	It displays The maximum page has been reached.
One page should exist at least	One page should exist at least.
Not used in current state	The current operation is not available.
Please reset first	Please reset first.

## 11.4 Troubleshooting

This section describes operations to be carried out by the user in case of failure of the instrument. Preparation before contact

When the instrument fails, check the following:

- Check whether the power meter is powered up.
- Check whether the power meter is started normally.
- Check whether the instrument fuse is in good conditions.
- Check whether other connectors are in good conditions and whether cables, plugs and other parts are connected properly.
- Check whether the system configuration of the instrument is correct during use.
- Check whether self-inspection of the instrument is successful and whether the specifications and performance are within the indicator ranges.

- Check whether the instrument displays error information.
- Use other instruments instead of this instrument for confirmation.

## Chapter 12

# LIMITED THREE-YEAR WARRANTY

B&K Precision Corp. warrants to the original purchaser that its products and the component parts thereof, will be free from defects in workmanship and materials for a period of **three years** from date of purchase.

B&K Precision Corp. will, without charge, repair or replace, at its option, defective product or component parts. Returned product must be accompanied by proof of the purchase date in the form of a sales receipt.

To help us better serve you, please complete the warranty registration for your new instrument via our website [www.bkprecision.com](http://www.bkprecision.com)

**Exclusions: This warranty does not apply in the event of misuse or abuse of the product or as a result of unauthorized alterations or repairs. The warranty is void if the serial number is altered, defaced or removed.**

B&K Precision Corp. shall not be liable for any consequential damages, including without limitation damages resulting from loss of use. Some states do not allow limitations of incidental or consequential damages. So the above limitation or exclusion may not apply to you.

This warranty gives you specific rights and you may have other rights, which vary from state-to-state.

B&K Precision Corp.  
22820 Savi Ranch Parkway  
Yorba Linda, CA 92887  
[www.bkprecision.com](http://www.bkprecision.com)  
714-921-9095

## Chapter 13

# Service Information

Warranty Service: Please go to the support and service section on our website at [bkprecision.com](http://bkprecision.com) to obtain a RMA #. Return the product in the original packaging with proof of purchase to the address below. Clearly state on the RMA the performance problem and return any leads, probes, connectors and accessories that you are using with the device. Non-Warranty Service: Please go to the support and service section on our website at [bkprecision.com](http://bkprecision.com) to obtain a RMA #. Return the product in the original packaging to the address below. Clearly state on the RMA the performance problem and return any leads, probes, connectors and accessories that you are using with the device. Customers not on an open account must include payment in the form of a money order or credit card. For the most current repair charges please refer to the service and support section on our website. Return all merchandise to B&K Precision Corp. with prepaid shipping. The flat-rate repair charge for Non-Warranty Service does not include return shipping. Return shipping to locations in North America is included for Warranty Service. For overnight shipments and non-North American shipping fees please contact B&K Precision Corp.

B&K Precision Corp.  
22820 Savi Ranch Parkway  
Yorba Linda, CA 92887  
[bkprecision.com](http://bkprecision.com)  
714-921-9095

Include with the returned instrument your complete return shipping address, contact name, phone number and description of problem.

Version – 2017-10-13